



---

# Western Canada Mine Rescue Manual

## Ministry of Energy and Mines

### Office of the Chief Inspector of Mines



Victoria  
British Columbia  
Canada

December 31, 1998

Revised 2014-15 (minor correction update – December 2016)

This manuscript is for educational purposes only. Nothing herein is to be regarded as indicating approval or disapproval of any specific product or practice.





---

## Foreword

Every mine has to maintain a mine rescue team to help ensure the safety of workers and property on mine sites throughout B.C., Yukon, Northwest Territories and Nunavut. This manual has been crafted to demonstrate the basic equipment, procedures, practices, and principles that mine rescue trainees need to know before they respond to incidents at surface and underground mining operations.

Mine Rescue teams have bravely responded to incidents and disasters throughout northern and western Canada for more than a century. It is through their training and practice that they have been able to come back safe and sound. Likewise, mine officials must also be familiar with their roles and responsibilities in the event of an emergency. Proper instruction must be complemented by individual and collective efforts to master the skills, equipment, and knowledge needed to execute a mine emergency response. This manual and training course represent the first steps you will take toward being able to answer that call.

There are all sorts of incidents and emergencies that Mine Rescue teams can encounter, including electrical fires, gas leaks, avalanches, and motor vehicle accidents. Mine Rescue can be dangerous work, especially if it is not performed properly. Rescuers are responsible first for their safety and the safety of their team, but some responses will also require that they tend to casualties in need of assistance. In consulting the most up-to-date research as well as experts in government and industry, the committee who created this manual have endeavoured to make certain that the information found in these pages is as reliable, applicable, and above all, safe as possible.

Your Mine Rescue training will not end when you finish this manual and course. Being a part of a Mine Rescue team means committing to a practice regime with your fellow Mine Rescuers to establish the cohesion, communication, and trust needed to function in the stressful environment of an emergency response. At times you may be called upon to assist in responses at other mining operations or to emergencies off-site. Wherever your Mine Rescue training takes you, wear the “MINE RESCUE” sticker on your hat with the pride and responsibility that it deserves.



Al Hoffman  
Chief Inspector of Mines,  
Ministry of Energy and Mines  
British Columbia



Bruce Milligan  
Director,  
Occupational Health and Safety  
Yukon Workers' Compensation  
Yukon



Peter Bengts  
Chief Inspector of Mines,  
Worker's Safety &  
Compensation Commission  
Northwest Territories and  
Nunavut

---

---

## Contents

Chapter 1 Introduction .....	1-1
INTRODUCTION .....	1-2
FUNDAMENTAL PRINCIPLES OF MINE RESCUE TRAINING .....	1-2
REQUIREMENTS FOR MINE RESCUE TRAINING .....	1-2
MINIMUM QUALIFICATIONS .....	1-3
MINE RESCUE CERTIFICATION .....	1-3
ACKNOWLEDGEMENTS .....	1-3
Chapter 2 Mine Rescue Organization .....	2-1
OBJECTIVES .....	2-2
CONCEPTS AND DEFINITIONS .....	2-2
THE MINE RESCUE TEAM .....	2-2
COMMUNICATION BY TEAM MEMBERS .....	2-5
DECISION-MAKING PROCESSES .....	2-5
PERSONAL PROTECTIVE EQUIPMENT .....	2-7
FRESH-AIR BASE/ZONE .....	2-7
FIRST RESPONSE TO HAZARDOUS MATERIALS .....	2-8
PHYSICAL/EMOTIONAL STRESS IN CRITICAL INCIDENTS .....	2-8
Chapter 3 Environmental Conditions .....	3-1
OBJECTIVES .....	3-2
CONCEPTS AND DEFINITIONS .....	3-2
AVALANCHE RESCUE GEAR .....	3-4
ICE TRAVEL .....	3-4
THERMAL STRESS .....	3-6
Chapter 4 Electrical Hazards .....	4-1
OBJECTIVES .....	4-2
CONCEPTS AND DEFINITIONS .....	4-2
INJURIES CAUSED BY SHOCKS AND ELECTROCUTIONS .....	4-5
ELECTRICAL HAZARDS ENCOUNTERED BY SPECIFIC WORK GROUPS .....	4-8
GUIDELINES FOR ELECTRICAL EMERGENCIES .....	4-9
Chapter 5 Gases and Hazardous Atmospheres .....	5-1
OBJECTIVES .....	5-2



---

CONCEPTS AND DEFINITIONS .....	5-2
ATMOSPHERIC HAZARDS DURING AND AFTER FIRES .....	5-21
Chapter 6 Rescue Tools .....	6-1
OBJECTIVES .....	6-2
CONCEPTS AND DEFINITIONS .....	6-2
GENERAL SAFETY CONSIDERATIONS .....	6-2
ROTATING TOOLS .....	6-3
PUSHING, PULLING, AND LIFTING TOOLS .....	6-3
PRYING AND SPREADING TOOLS .....	6-4
STRIKING TOOLS .....	6-4
CUTTING TOOLS .....	6-5
ENERGY SOURCES.....	6-5
HAZARDOUS ATMOSPHERE AND SPILL TOOLS.....	6-6
FIRE APPLIANCES .....	6-6
MISCELLANEOUS TOOLS .....	6-7
Chapter 7 Gas Detection Instruments .....	7-1
OBJECTIVES .....	7-2
SELECTING GAS DETECTION EQUIPMENT .....	7-2
GAS DETECTOR TYPES.....	7-3
PRACTICAL SKILLS FOR GAS DETECTION .....	7-5
Chapter 8 Respiratory Protective Equipment .....	8-1
OBJECTIVES .....	8-2
APPARATUS CONCEPTS.....	8-3
SELF-RESCUERS.....	8-4
SELF-CONTAINED SELF-RESCUERS (SCSR) .....	8-6
SELF-CONTAINED BREATHING APPARATUS .....	8-8
CYLINDER TESTING AND CHARGING.....	8-9
Chapter 9 Oxygen Therapy .....	9-1
OBJECTIVES .....	9-2
SAFE STORAGE, TRANSPORT, AND USE .....	9-2
WHEN TO USE OXYGEN THERAPY .....	9-3
BENEFITS OF OXYGEN THERAPY .....	9-3

---

OXYGEN THERAPY EQUIPMENT .....	9-4
INSPECTING CYLINDERS AND ASSEMBLING COMPONENTS .....	9-7
ADMINISTERING OXYGEN .....	9-7
SHUT DOWN PROCEDURE.....	9-8
OXYGEN CYLINDER DURATION.....	9-8
Chapter 10 Fire.....	10-1
OBJECTIVES .....	10-2
PERSONAL PROTECTIVE EQUIPMENT .....	10-2
FIRE BEHAVIOUR .....	10-3
CLASSIFICATION OF FIRES .....	10-9
PHASES OF FIRE .....	10-10
HAZARDS OF FIRE DEVELOPMENT .....	10-11
VENTILATION.....	10-17
EQUIPMENT FIRES .....	10-18
BLEVE (BOILING LIQUID EXPANDING VAPOUR EXPLOSION).....	10-18
Chapter 11 Rope Rescue.....	11-2
OBJECTIVES .....	11-3
PERSONAL PROTECTION EQUIPMENT .....	11-4
HARDWARE .....	11-8
KNOTS, BENDS, AND HITCHES.....	11-12
HARNESSES.....	11-16
ANCHORS .....	11-36
MECHANICAL ADVANTAGES .....	11-41
BELAYS .....	11-47
RAPPELLING.....	11-51
Chapter 12 Underground Operations.....	12-1
OBJECTIVES .....	12-2
A GUIDE FOR PLANNING MINE EMERGENCY PROCEDURES .....	12-2
FIRE CONTROL AND VENTILATION .....	12-4
INSTRUMENTS USED IN VENTILATION WORK.....	12-8
MINE DRAWINGS.....	12-9
UNDERGROUND MINE FIRES — CONTROL AND SUPPRESSION.....	12-11

---

Chapter 13 Operations Skills.....	13-1
OBJECTIVES .....	13-2
USE OF PORTABLE FIRE EXTINGUISHERS .....	13-2
SEARCH AND RESCUE.....	13-2
STANDARD SEARCH PROCEDURE .....	13-3
CASUALTY MANAGEMENT .....	13-5
EXTRICATION FROM VEHICLES AND EQUIPMENT .....	13-5
SUPPLEMENTARY RESCUE TECHNIQUES .....	13-6
Appendix.....	





## Western Canada Mine Rescue Manual

# Chapter 1 Introduction



---

## **INTRODUCTION**

This manual is designed to provide basic training in the rescue procedures to be followed in the event of an incident requiring emergency response at a surface or underground mining operation. The mining laws of all jurisdictions in Western Canada require that trained, properly equipped mine rescue teams be maintained at all surface and underground mining operations.

It is the management's responsibility to appoint a qualified person as a trainer for mine rescue training and to ensure that all mine rescue team members practice as a team. The appointed rescue trainer is responsible for maintaining a log of dates, times, training material, and equipment used at practice sessions. All records must be signed off by employers and trainees. A properly planned training agenda should be constructed so as to achieve the maximum training results for the allotted training time, as stipulated by local legislation.

## **FUNDAMENTAL PRINCIPLES OF MINE RESCUE TRAINING**

The fundamental principles of mine rescue training are, in order of importance:

- Ensuring the safety of self and rescue team
- Endeavouring to rescue or ensuring the safety of trapped or injured workers
- Protection of the mine property from further damage
- Rehabilitation of the affected work area and salvage of equipment

Through training, mine rescue teams will become familiar with:

- Mine rescue equipment
- Mining equipment that may be useful in an emergency (cranes, loaders, scoop trams, etc.)
- Hazards involved in mine rescue work (toxic and flammable gases, electricity, rock-falls, etc.)
- The most common dangerous occurrences, such as those involving fire, machinery, or electricity

## **REQUIREMENTS FOR MINE RESCUE TRAINING**

Mine rescue work is physically and mentally demanding, and at times dangerous. Members of mine rescue teams must not only have an intimate knowledge of their equipment but must also be physically sound and fit to perform strenuous work while wearing a breathing apparatus. In addition, they must maintain good judgement and temperament. They should be selected carefully and must receive thorough training.

Frequent additional training and instruction should be given in an irrespirable atmosphere to ensure that both crew and equipment are in condition to respond to an emergency. Training exercises involving a recovery problem should be conducted occasionally. Many hours of training and practice are needed to develop a competent mine rescue team that can work effectively with other teams to accomplish rescue objectives in the event of a mine emergency.

It is also most important that mine officials receive periodic instruction and training in the duties they must perform, both individually and collectively, should an incident arise requiring a mine rescue response. They must know where tools, equipment and materials can be obtained, both on the mine site and from outside sources.

---

All supervisory staff should be instructed that, in the absence of higher authority, they must take charge, and act on matters requiring immediate attention. They must notify all persons required to assist at a disaster, particularly the regulator responsible for the district in which the mine is located, the mine rescue team, and any other help that may be available.

## MINIMUM QUALIFICATIONS

Candidates for mine rescue training must meet the following minimum requirements:

- Minimum age of 18 years
- Speak, read, and write English\*
- Be in good physical and mental condition\*
- Be familiar with mining conditions, practices, hazards and equipment
- Have no perforated eardrums (tympanic membrane)\*
- Hold a valid Standard First Aid Certificate with spinal immobilization training or its equivalent
- Clean-shaven, with no facial hair to interfere with the seal on the breathing apparatus.
- Hold any additional certifications as required by your jurisdiction

Whether a candidate is trained in underground mine rescue, surface mine rescue, or first aid, the applicant must be mentally and physically capable and prepared to render assistance whenever called upon to do so.

\* = Subject to the discretion of the mine manager

## MINE RESCUE CERTIFICATION

The Basic Underground or Surface Mine Rescue Certificate will be issued to candidates who successfully complete the training course. The candidate must attain a grade of 70% upon examination to pass. Continuous participation in mine rescue service while maintaining the above minimum requirements will ensure that the certification does not expire. A rescuer may apply for an advanced certificate after five years of service in addition to fulfilling further competencies.

## ACKNOWLEDGEMENTS

This Mine Rescue Manual has evolved from integrating revised editions of the General Underground Mine Rescue Manual (British Columbia Ministry of Energy, Mines and Petroleum Resources, Paper 1977-2) and the Surface Mine Rescue Manual (British Columbia Ministry of Energy, Mines and Petroleum Resources, Paper 1981-4). The manual was compiled by **Mike Barber** and **Haley Koppers**, in cooperation with a steering committee drawn from the coal- and metal-mining industries in British Columbia, Yukon, Northwest Territories, and Nunavut. The compilers gratefully acknowledge the contribution made by members of the steering committee in 2013–14, specifically:

Jerrold Jewsbury	British Columbia Ministry of Energy and Mines
Gerry Wong	Teck Highland Valley Copper
Nathan Pitre	Diavik Diamond Mines (2012) Inc.
Lex Lovatt	Workers Safety and Compensation Commission of the Northwest Territories and Nunavut
Ron Ratz	Yukon Workers Compensation Health and Safety Board

---

Considerable assistance in creating and reviewing content for the manual was provided by:

- East Kootenay Mining Industry Safety Association (B.C.)
- North/Central/South Mine Rescue (B.C.)
- Northern Mine Safety Forum
- Yukon Mine Producers Group

The manual also draws on a number of earlier publications, including:

- The Handbook of Training in Mine Rescue and Recovery Operations, *Ontario Ministry of Labour*
- Mine Rescue Crisis Response Manual, *Yukon Territorial Government*
- Occupational First Aid Manual, *British Columbia Workers' Compensation Board*
- Electrical Safety for Policemen and Firemen, *B.C. Hydro*
- Rigging for Rescue, *Dynamic Rescue Systems*
- Operation Recharge Inspection and Maintenance Manual – Cartridge Dry Chemical Fire Extinguishers, *ANSUL*
- Manitoba Mine Rescue Training and Reference Manual, *Manitoba Ministry of Mineral Resources*
- Alberta Mine Rescue Manual, *Alberta Mine Safety Association*
- Saskatchewan Mine Emergency Response Program, *Saskatchewan Labour Occupational Health and Safety*
- The Canadian Electrical Code, *Canadian Standards Association*
- Various publications of *American Congress of Governmental Industrial Hygienists (ACGIH)*, *National Institute for Occupational Safety, and Health (NIOSH)*, *Environment Canada*, *Canadian Centre for Occupational Health and Safety (CCOHS)*, and *Health Canada*

A number of photos in this manual are used courtesy of the manufacturers and rights holders, including:

- |                         |                             |                     |
|-------------------------|-----------------------------|---------------------|
| • Draeger Canada        | • vRigger                   | • AnimatedKnots.Com |
| • Ferno Canada          | • Canadian Safety Equipment | • Carleton Rescue   |
| • CMC Rescue            | • Scott Safety              | • Gastec            |
| • Biomarine Inc.        | • MSA Canada                |                     |
| • Industrial Scientific | • O-Two                     |                     |
| • Honeywell Analytics   |                             |                     |

These sources are gratefully acknowledged.

**This manual is intended to cover basic mine rescue principles, techniques, and equipment. Familiarize yourself with site-specific procedures, manufacturer's instructions, and other training programs available to supplement this course.**





---

## Western Canada Mine Rescue Manual

# Chapter 2 Mine Rescue Organization

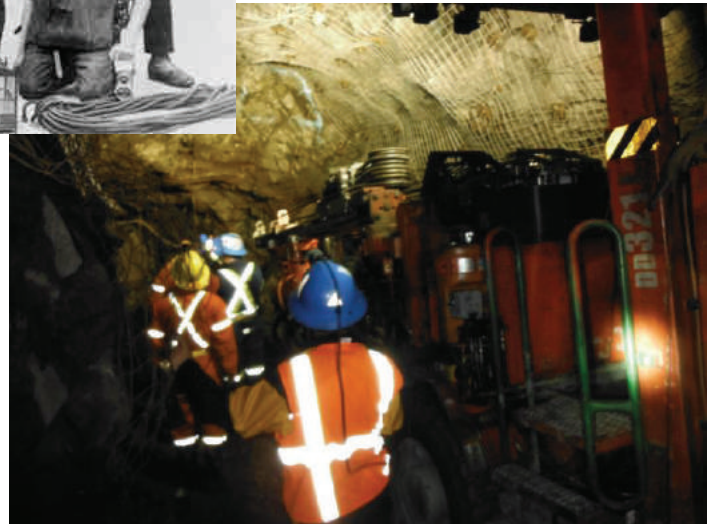

---

## OBJECTIVES

Before learning the skills necessary to complete mine rescue operations, trainees must understand how teams and rescue operations are organized. Upon completing this chapter, the trainee shall be able to demonstrate competency in:

- Mine Rescue Team Structure
- Communications by Team Members
- Decision-making Processes
- Personal Protective Equipment requirements
- Fresh Air Bases/Zones
- First Response to Hazardous Materials
- Physical/Emotional Stress in Critical Incidents

## CONCEPTS AND DEFINITIONS

A **Mine Emergency Response Plan (MERP)** is the company's guide to all procedures and plans of action in the case of an emergency on-site. This plan describes roles and responsibilities for management, rescue teams, and support personnel.

An **Incident Management System**, such as Incident Command System (ICS), allows for command, control, and co-ordination during emergency response. The incident management system is a component of a MERP.

## THE MINE RESCUE TEAM

**Mine rescue teams** are called upon to respond to many different kinds of emergencies. Time will be an important factor, and the following practices will help teams work efficiently in an emergency:

1. The first and foremost is team structure. This leads to successful efforts in disciplines such as extrication techniques, first aid methods and firefighting procedures that require a team effort.
2. The team should plan and practice basic procedures **prior** to an emergency situation.

### The Captain

The Captain is the No. 1 member on the team. Above all, the Captain must be a competent leader who has the confidence and respect of team members. The Captain must be in good physical and mental condition and experienced in every aspect of emergency response. The Captain's responsibilities include:

- Ensuring team is response-ready
- Ensuring breathing apparatus and auxiliary equipment are response-ready
- Ensuring safe operation of all rescue equipment
- Communicating within the emergency response structure
- Knowledge of all facilities at the mine and relevant fire, explosive, electrical, mechanical, and chemical hazards
- Knowledge of ventilation principles
- Knowledge of mine gases
- Directing and assisting the work of team members at the scene
- Determining and inspecting all aspects of a rescue operation
- Establishing and maintaining incident scene security and control

---

### The Vice-Captain

The Vice Captain of a surface mine rescue team is the No. 2 member. In underground teams, the Vice-Captain is the No. 5 member. In the event that the Captain is unable to perform the assigned responsibilities, the Vice-Captain must take control of the team and therefore must have the same qualifications as the Captain.

Vice-Captains are also responsible for monitoring members of the team and warning the Captain if any member shows signs of distress or fatigue during a response. They must also make certain that team members rotate while carrying a stretcher over distances to prevent fatigue.

### Team Members

A standard mine rescue team has six members including the Captain. The sixth member of an underground team is the **Co-ordinator** and provides direction from the surface incident command centre to the underground team Captain. All team members are responsible for recognizing hazards and relaying that information to other team members. The team must be rested regularly and be constantly observed for signs of distress in any member. Work must be distributed as evenly as possible among all members. Team Captains will delegate duties among the other team members, such as:

- Exploring affected area of the mine
- Rope work and rigging
- Firefighting
- First Aid
- Extrication

Teams may add members during a response based on their requirements or the members' specific skill set. Any additional team members must have a number assigned to them in sequence beyond the six original members.

### Mutual Aid

Large incidents may require assistance from other mines or emergency agencies. This collaboration is known as **mutual aid** and is a component of a MERP. When collaborating with mine rescue teams, it is imperative to follow the same numbering format for team designations. This will ensure that communications between incident management and each responding team are aligned with the MERP and that all responsibilities are assigned in an orderly manner. If extra personnel are added to a team, each rescuer will be assigned team numbers continuing from the basic six (team member 7, 8, 9, etc.).

### Mine Rescue Unit

The mine rescue unit consists of a minimum of three mine rescue teams summoned to a mine disaster. If the operation extends beyond six hours, additional teams must be called in. To reduce fatigue, the teams rotate to allow one team at work, one team on hand as backup, and the third team at rest. Typical rotations for a three-, six-, and nine-team units are as follows:

Active Team (Max. 2 hrs.)	Back-up Team	Team at Rest
A-team	B-team	C-team
B-team	C-team	A-team
C-team	A-team	B-team

Fig 2.1: This table shows a rotation of mine rescue teams in a six-team arrangement. The arrangement allows for each rotation to have six hours on duty (two hours active, two hours standby and two hours reserve) followed by six hours of rest.

													DATE:	
													TIME	
TEAM #	DESCRIPTION													
1		ACTIVE				RESERVE	STAND BY	ACTIVE				RESERVE	STAND BY	
2		STAND BY	ACTIVE				RESERVE	STAND BY	ACTIVE				RESERVE	
3		RESERVE	STAND BY	ACTIVE				RESERVE	STAND BY	ACTIVE				
4			RESERVE	STAND BY	ACTIVE				RESERVE	STAND BY	ACTIVE			
5				RESERVE	STAND BY	ACTIVE				RESERVE	STAND BY	ACTIVE		
6					RESERVE	STAND BY	ACTIVE					RESERVE	STAND BY	ACTIVE
													SIGNED:	

Fig. 2.2: This table shows a rotation of Mine Rescue teams in a nine-team arrangement. With a nine-team rotation, the rest time will be extended to match the teams deployed to the mine emergency.

													DATE:	
													TIME	
TEAM #	DESCRIPTION													
1		ACTIVE								RESERVE	STAND BY	ACTIVE		
2		STAND BY	ACTIVE								RESERVE	STAND BY	ACTIVE	
3		RESERVE	STAND BY	ACTIVE								RESERVE	STAND BY	ACTIVE
4			RESERVE	STAND BY	ACTIVE								RESERVE	STAND BY
5				RESERVE	STAND BY	ACTIVE								RESERVE
6					RESERVE	STAND BY	ACTIVE							
7						RESERVE	STAND BY	ACTIVE						
8							RESERVE	STAND BY	ACTIVE					
9								RESERVE	STAND BY	ACTIVE				
													SIGNED:	

---

## COMMUNICATION BY TEAM MEMBERS

All members of a mine rescue team must observe strict discipline and must obey all directions given to them by the Team Captain. Primary communication is done via electronic devices, such as phones or intrinsically safe radios where required.

Surface team members should all carry whistles for secondary communication. On underground teams, the Captain and the Vice-Captain will both carry a horn, bell, whistle, or use other site-specific methods or devices. A standard set of signals has been established.

Standard Code of Signals	
<b>One</b>	To advance if stopped; to stop if in motion.
<b>Two</b>	To rest.
<b>Three (Distress)</b>	This signal will often be given by the Vice-Captain as he is observing the team members during travel and will be first to notice signs of distress.
<b>Four (Attention)</b>	At this signal, all team members will look at the person giving the signal and receive further instructions
<b>Five (Retreat)</b>	At this signal, the team will immediately retreat in the direction from which they have come. The Vice-Captain (underground) may lead the team in retreat for short distances through areas already explored, but should not lead the team into unexplored areas. As soon as circumstances permit, the Captain should resume the responsibility of leading the team.

## DECISION-MAKING PROCESSES

Mine rescue responsibilities can be very demanding. Mine rescue members may be the first trained personnel to arrive at the incident scene. They are required to:

- Control the scene
- Ensure the MERP is initiated
- Ensure the safety of self and team, casualties, and bystanders
- Assist with casualty extrication and first aid
- Fight fires
- Control chemical spills

### Response and Size Up

**Response** begins when a rescue team is alerted to an incident. It involves safely travelling to and arriving at the incident scene, then staging and securing equipment and vehicles. Response elements include:

- Preparation: Ensuring equipment, including PPE, is in its designated location; familiarity with facilities, response procedures, and pre-incident plans
- Method of alert/notification: Alarms, two-way radio, telephone, pager
- Establish communication within the rescue team and between team and command structure
- Safe travel to incident: Seatbelts, route, site specific traffic rules, exiting the vehicle
- Arrival at the scene:
  - **Accountability:** Under the command structure, account for the responding rescue team members first then for all personnel at the incident scene.
  - **Freelancing:** Acting independently of command instruction is unacceptable and must not be tolerated.

---

## Identify the Problem

**Size up** is a systematic process of gathering information and situational evaluation that continues throughout the operation. Size up is essential to accomplish a safe and efficient rescue operation. There are four parts to size up:

1. Information gathered from the initial call:
  - Nature and location of emergency
  - Number of people/injuries involved
  - Weather conditions
  - Time of day
  - Equipment involved and access to the scene
2. Details observed en route:
  - Power blackouts
  - Smoke in the direction of the emergency
  - Traffic (unusual flow or congestion) and bystanders
3. Details observed at the scene:
  - Signs of hazardous conditions observed while establishing perimeter
  - Confirm / compare observations to information given in the initial call
  - Gasoline or fuel, chemical release or spill
  - Location of casualties
  - Actions that may have been taken by people already at the scene
4. Information gathered during size up is either factual (known or confirmed) or probable (assumptions made based on situation). For example, building occupancy based on time of day would be classified as probable.

**Hazard assessment** involves identifying and evaluating hazards that may be encountered during the rescue operation. These hazards include:

- Fire
- Hazardous atmospheres (e.g., chemical hazards, toxic gases, oxygen displacement)
- Energy sources (e.g., electrical, gas, nuclear)
- Physical (e.g., structure, traffic, topography)
- Biological
- Environmental
- Evaluate all influencing factors (e.g., time, location, environment, weather)

## Formulate an objective based on known information and resources

- Determine what resources are required to accomplish the task (e.g., offensive or defensive)
- Risk-based decision-making based on the fundamental principles of mine rescue

## Select one or more alternatives from the available options

- Choose priorities based on the task and the resources available.

## Take appropriate action

- Conduct all activities in a manner that ensures the safety of team members, casualties, and bystanders.

## Analyze results

- Continuous process throughout the response
- Be prepared to choose an alternative action if results are unsatisfactory.



---

## FIRST RESPONSE TO HAZARDOUS MATERIALS

Rescue members should be competent in site-specific response procedures. In the event of any incident involving hazardous materials, rescuers can refer to:

- The Emergency Response Guidebook for Incidents Involving Hazardous Materials
- Material Safety Data Sheets (MSDS) or Information Sheets provided by the manufacturer for all products on-site
- CANUTEC (Canadian Transport Emergency Centre, a 24-hour national emergency response advisory service) and WISER (Wireless Information System for Emergency Responders)
- On-site expertise

## PHYSICAL/EMOTIONAL STRESS IN CRITICAL INCIDENTS

A **critical incident** is an event that is outside the range of usual human experience and is psychologically traumatic to the person.

Critical incidents may produce a wide range of stress reactions, which can appear immediately at the scene, a few hours later or within a few days of the event. Stress reactions usually occur in four different categories:

- Cognitive (thinking)
- Physical (body)
- Emotional (feelings)
- Behavioural (actions)

The more reactions experienced, the greater the impact on the individual. The longer the reactions last, the more potential there is for permanent harm. These stresses can cause a wide variety of reactions:

Category	Symptoms	
Cognitive	Poor concentration	Memory problems
	Poor attention span	Difficulty with calculations
	Indecision	Slowed problem solving
Emotional	Loss of emotional control	Feeling lost or overwhelmed
	Depression	Anxiety/Fear
	Guilt	Grief
Physical	Muscle tremors	Chest pains
	Gastrointestinal distress	Difficulty breathing
	Headaches	Elevated blood pressure
Behavioural	Excessive silence	Atypical behaviour
	Withdrawal from contact	Sleep disturbance
	Change in eating habits	Change in work habits

These conditions result from the effects of the body's chemical emergency response system.

Following the completion of a mine rescue emergency response, mine rescue teams must hold a debriefing. A **Critical Incident Stress Debriefing (CISD)** or other counselling procedures should be conducted with all personnel directly involved in a **Critical Incident**. The debriefing should be held immediately at the end of the emergency response and be facilitated by qualified professionals.





---

Western Canada Mine Rescue Manual

# Chapter 3 Environmental Conditions



---

## OBJECTIVES

Mine rescue teams should be aware of the special dangers associated with environmental conditions. This chapter will provide a basic understanding of:

- Avalanche terms, concepts, and equipment
- Ice travel
- Thermal stress

## CONCEPTS AND DEFINITIONS

Mines operating in avalanche-prone areas must develop an **avalanche emergency response plan** tailored to their mine. Mine rescue personnel may be required to perform emergency response activities that expose them to avalanche hazards. This chapter is intended to only provide basic avalanche awareness.

A qualified **avalanche safety officer** must be identified, consulted, and lead the safe emergency response in an active avalanche situation. The avalanche safety officer must conduct an avalanche risk assessment and establish active avalanche safety measures prior to planning emergency operations.

An **avalanche** is a rapid flow of snow down a sloping surface that can occur at any time provided the right conditions are present. Avalanches have three main parts:

- **Starting zone** (point of origin): Where the unstable snow first breaks away. An avalanche path may have several starting zones. Characteristics of starting zones include: incline, slope aspect, exposure to wind, elevation, exposure to sun, natural ground condition.
- **Track** (zone of transition): Below the starting zone, where the avalanche accelerates and typically reaches maximum destructive potential. It will have the potential to overrun terrain features and previous avalanche tracks. Avalanche areas can contain one or more tracks. These tracks may be poorly or clearly defined.
- **Run-out zone**: Where the avalanche decelerates and finally comes to rest. It can be identified as a zone where the bulk of the snow is deposited.

Avalanches may occur anywhere given the following conditions:

- Geography, such as the natural topography of the area, engineered land forms, and slope orientation.
- Snow accumulates on a moderate to steep slope (30°–45°). Avalanches rarely start on slopes steeper than 45° as snow sloughs off continuously rather than accumulating.
- Snow conditions, such as:
  - Snow pack (accumulation)
  - Mass
  - Layers of snow and bonding between facet layers
  - Environmental effects: Variation in temperature, wind, humidity

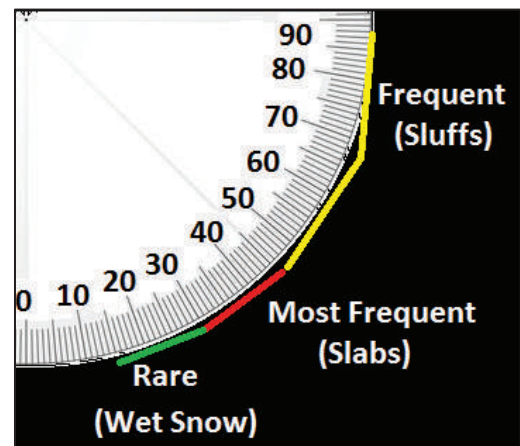

Fig 3.1 Slope steepness and avalanches

- An external event that triggers the slide. These can be:
  - **Natural:** New snow, transported snow (wind), temperature changes, sun, rain, thawing and animals.
  - **Human:** Explosives, working on a slope, working below a slope, mobile equipment, and recreational activities.
  - **Trigger points:** Snow conditions, shallow areas/variable depth snow packs, points of weakness (e.g., trees, rock outcrops) may all contribute to the development of avalanche conditions.

Two types of avalanche are commonly recognized:

**Loose Snow Avalanches** may consist of dry powder snow or wet snow. Dry snow avalanches are most common in winter after storms and rare in spring or summer. Wet snow avalanches consist of heavy, wet, sun-heated or rain-rotted snow or wet new snow and are most common in spring and summer, particularly on south-facing slopes.

These avalanches:

- Start from a point
- Are set in motion progressively
- Require snow with poor cohesion, similar to that of dry sand
- Are usually confined to surface layers and therefore relatively small



**Slab Avalanches** occur when a slab of fairly cohesive layers of snow, poorly bonded to the snow underneath, breaks off along a fracture line. These avalanches are by far the most dangerous. They are set in motion simultaneously, over a large area and may start in either shallow or deep snow layers.

### Safety in Avalanche Zones

The successful rescue of a person buried in an avalanche very often depends upon actions taken by unburied survivors. Teams performing rescue operations in an avalanche area must be mentally prepared for the possibility that they too may be overtaken by an avalanche.

If crossing an avalanche track cannot be avoided, take the following precautions:

- Select the shortest possible route high on the slope or low in the run-out zone
- Plan an escape route.
- Wear mitts and hats. Tighten clothing and smaller packs. Loosen larger packs in case they need to be quickly removed.
- Assign a spotter at the top and bottom of the track and agree on a warning signal.
- Cross quickly. If the crossing is narrow, one person crosses at a time. Otherwise, maintain space between rescuers to minimize the risk of exposure to an avalanche track.

---

## AVALANCHE RESCUE GEAR

**Probe, Avalanche transceiver (beacon), and Shovel:** These three items work together and are the minimum required equipment for every avalanche rescuer. For proper use of avalanche rescue gear, refer to manufacturer's guidelines.



*L-R: Probe, Shovel, Transceiver (bottom)*

## ICE TRAVEL

Some mining operations in remote northern locations are accessed by **ice roads** built on frozen lakes and rivers.

### Prior to travelling on ice

The thickness of the ice must be tested frequently in various locations. The smallest thickness is what is used to determine the strength of the ice. Table 3.1 indicates the weight that will be supported by varying thicknesses of clear blue lake-ice, provided the load remains in motion.

- Type of ice:
  - River or lake (movement of water beneath ice). Clear blue river-ice, with moving water beneath it, is not as strong as lake-ice. Loads should be reduced by at least 15%
  - Clear or natural ice (black or blue hue). This is considered the strongest form of ice.
  - Slush ice (white hue) is snow saturated with water. It is commonly found as new ice floating after a heavy snowfall. It is much weaker than clear blue lake-ice.
- Cracks in ice may affect its ability to support a load.

### While traveling on ice

- As a vehicle travels on ice it creates a resonance wave in the underlying water. The weight and speed of the vehicle, as well as the depth of the water, influence the size and speed of the wave. The resonance wave can affect the strength of the ice, potentially resulting in a **blowout**, or an ice failure.
- Unless otherwise posted, the speed limit on ice roads is 25 km/h for a loaded vehicle and 35 km/h for an empty vehicle.

The following table shows the maximum allowable mass of a vehicle in motion for ice of various thicknesses. Gold's Formula for determining the maximum allowable mass is:

$$M = 4 \times h^2$$

where  $M$  is the mass of the vehicle (kg) and  $h$  is the thickness of the ice (cm)

Ice Thickness – Clear Blue Lake Ice					
Ice Thickness (cm)	Capacity (kg)	Ice Thickness (cm)	Capacity (kg)	Ice Thickness (cm)	Capacity (kg)
2.5	25	37.5	5,625	75	22,500
3.5	49	40	6,400	77.5	24,025
5	100	42.5	7,225	80	25,600
7.5	225	45	8,100	82.5	27,225
10	400	47.5	9,025	85	28,900
12.5	625	50	10,000	87.5	30,625
15	900	52.5	11,025	90	32,400
17.5	1,225	55	12,100	92.5	34,225
20	1,600	57.5	13,225	95	36,100
22.5	2,025	60	14,400	97.5	38,025
25	2,500	62.5	15,625	100	40,000
27.5	3,025	65	16,900	102.5	42,025
30	3,600	67.5	18,225	105	44,100
32.5	4,225	70	19,600	107.5	46,225
35	4,900	72.5	21,025	110	48,400

Table 3.1 – Ice Strength

## THERMAL STRESS

**Thermal stress** refers to a range of physiological reactions to adverse temperature conditions. There are many factors that contribute to these stresses. Mine rescuers must be able to recognize and adequately respond to these conditions.

**Hypothermia** is a condition of lowered internal body-core temperature (exposure sickness). Failure to recognize symptoms of hypothermia is the leading cause of death for people in the outdoors. Hypothermia is caused by overexposure to a cold environment and can develop very quickly if proper precautions are not taken. Hypothermia results from chilling by cold, wind, or water such that the body loses heat faster than it can produce it.

Factors contributing to the development of hypothermia include:

- Inadequate clothing
- Alcohol or drugs in the body
- Wetness (perspiration, rain)
- Exhaustion, dehydration, and lack of nutrition
- Wind and water
- Temperature
- Duration of exposure

Hypothermia and Water Immersion		
If water temperature (C) is...	Exhaustion or Unconsciousness	Expected survival time
0	< 15 minutes	15–45 minutes
1–5	15–30 minutes	30–90 minutes
5–10	30–60 minutes	1–3 hours
10–15	1–2 hours	1–6 hours
15–20	2–7 hours	2–40 hours
20–25	3–12 hours	3 hours–indefinitely
25–30	Indefinitely	Indefinitely

### Symptoms of Hypothermia

Visible symptoms indicate the onset of hypothermia. Its advance is marked by recognizable stages.

Stage	Core Temperature (C)	Signs & Symptoms
Mild Hypothermia	37.2–36.1	Normal, shivering can begin
	36.1–35.0	Cold sensation, goose bumps, unable to perform complex tasks with hands, shiver can be mild to severe, hands numb
Moderate Hypothermia	35.0–33.9	Shivering, intense, lack of muscle coordination becomes apparent, movements slow and labored, stumbling pace, mild confusion, may appear alert. Use sobriety test: if unable to walk a 30 foot straight line, the person is hypothermic.
	33.9–32.2	Violent shivering persists, difficulty speaking, sluggish thinking, amnesia starts to appear, gross muscle movements sluggish, unable to use hands, stumbles frequently, difficulty speaking, signs of depression, withdrawn.
Severe Hypothermia	32.2–30.0	Shivering stops, exposed skin blue or puffy, muscle coordination very poor, inability to walk, confusion, incoherent/irrational behavior, but may be able to maintain posture and appearance of awareness
	30.0–27.8	Muscle rigidity, semiconscious, stupor, loss of awareness of others, pulse and respiration rate decrease, possible heart fibrillation
	27.8–25.6	Unconscious, heart beat and respiration erratic, pulse may not be palpable
	25.6–23.9	Pulmonary oedema, cardiac and respiratory failure, death. Death may occur before this temperature is reached.

## Bodily Heat Loss

The head and neck are the most critical heat-loss areas. Other body areas have high rates of heat loss while a subject is holding still in cold water. Infrared pictures show that the sides of the chest (where there is little muscle or fat) are the major routes for heat loss from the warm chest cavity. The groin area also loses much heat due to the large blood vessels near the surface. If an effort is made to conserve body heat, these regions deserve special attention.

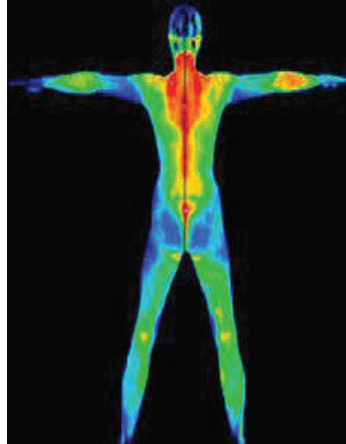

*Fig 3.2: This infrared image of a body shows high-heat areas (red) and low-heat areas (blue)*

## Cold Water Survival Techniques

Mine rescuers that work near water require personal floatation devices (PFD). The onset of hypothermia is much quicker for people immersed in cold water. These two techniques can extend predicted survival times:



### H.E.L.P. (Heat Escape Lessening Position)

This technique for cold water survival protects the parts of the body that lose heat fastest. It increases predicted survival time by up to 50%. This position requires a floatation device that maintains upper-body buoyancy.

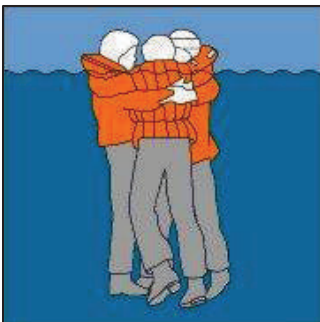

### Huddle Position

Predicted survival time can be increased by up to 50% if survivors huddle together. In this position, the sides of the survivors' chests are held close together to prevent heat loss.

**In cold water (<10 C), the average person can swim no more than one-tenth the distance they can in warm water.**

### Cold Stress Conditions

Exposure to cold environments or water for a prolonged period can result in a number of adverse conditions. Particularly during winter months, precautions should be taken to avoid these conditions during mine rescue work.

Condition	Cause	Symptoms (may or may not be present)
<b>Chilblains</b>	<ul style="list-style-type: none"> <li>• Prolonged and repeated exposure for several hours to air temperatures from above freezing to as high as 16 C</li> </ul>	<ul style="list-style-type: none"> <li>• Affected skin area there will have redness, swelling, tingling, and pain</li> </ul>
<b>Frostnip</b>	<ul style="list-style-type: none"> <li>• Ear lobes, noses, cheeks, fingers, or toes are exposed to the cold and the top layers of skin freeze</li> </ul>	<ul style="list-style-type: none"> <li>• Affected skin turns white and may feel numb.</li> <li>• Top layer of skin feels hard but the deeper tissue still feels soft</li> </ul>
<b>Frostbite</b>	<ul style="list-style-type: none"> <li>• Exposure to extreme cold or by contact with extremely cold objects (especially those made of metal). It may also occur in normal temperatures from contact with cooled or compressed gases.</li> <li>• Frostbite occurs when tissue temperature falls below the freezing point, or when blood flow is obstructed.</li> </ul>	<ul style="list-style-type: none"> <li>• Mild cases: Inflammation of the skin in patches accompanied by slight pain</li> <li>• Severe cases: Tissue damage without pain, or there could be burning or prickling sensations resulting in blisters</li> <li>• Blood vessels may be severely and permanently damaged, and blood circulation may stop in the affected tissue</li> <li>• Frostbitten skin is highly susceptible to infection, and gangrene (local death of soft tissues due to loss of blood supply) may develop</li> </ul>
<b>Immersion Foot/Trench Foot</b>	<ul style="list-style-type: none"> <li>• Occurs when feet have been wet, but not freezing cold, for prolonged periods of time</li> <li>• Can occur at temperatures up to 10 C</li> <li>• Trench foot is more likely to occur at lower temperatures</li> <li>• Immersion foot is more likely to occur at higher temperatures and longer exposure times.</li> <li>• Hands can be affected if a person wears wet gloves for a prolonged period under cold conditions</li> </ul>	<ul style="list-style-type: none"> <li>• Tingling and numbness</li> <li>• Itching, pain, or swelling of the legs, feet, or hands</li> <li>• Blisters</li> <li>• Skin turns red then blue or purple</li> <li>• Gangrene may develop</li> </ul>



## Heat Stress Conditions

As with cold stress conditions, the severity of heat stress conditions depends on duration and intensity of exposure and activity, as well as the patient's fitness and health.

Condition	Cause	Symptoms (may or may not be present)
<b>Heat Rash</b>	<ul style="list-style-type: none"> <li>• Hot, humid environment</li> <li>• Plugged sweat glands</li> </ul>	<ul style="list-style-type: none"> <li>• Red bumpy rash with severe itching</li> </ul>
<b>Heat Cramps</b>	<ul style="list-style-type: none"> <li>• Heavy sweating from strenuous physical activity drains a person's body of fluid and salt.</li> </ul>	<ul style="list-style-type: none"> <li>• Painful cramps occur in the most commonly worked muscles (arms, legs, abdominals)</li> <li>• Onset can be immediate or delayed.</li> </ul>
<b>Heat syncope (fainting)</b>	<ul style="list-style-type: none"> <li>• Fluid loss</li> <li>• Inadequate water intake</li> <li>• Standing still resulting in decreased blood flow to brain</li> </ul>	<ul style="list-style-type: none"> <li>• Sudden fainting after at least two hours of work</li> <li>• Cool, moist skin</li> <li>• Weak pulse</li> </ul>
<b>Heat Exhaustion</b>	<ul style="list-style-type: none"> <li>• Fluid loss and inadequate salt and water intake causes the body's cooling system to start to break down.</li> </ul>	<ul style="list-style-type: none"> <li>• Heavy sweating</li> <li>• Cool, moist skin</li> <li>• Elevated body temperature</li> <li>• Weak pulse</li> <li>• Normal or low blood pressure</li> <li>• Fatigue, weakness, nausea and vomiting</li> <li>• Thirst</li> <li>• Panting or rapid breathing</li> <li>• Blurred vision</li> <li>• Dizziness</li> <li>• Oedema</li> <li>• Light headedness</li> </ul>
<b>Heat Stroke</b>	<ul style="list-style-type: none"> <li>• If a person's body has used up all its water and salt reserves, it will stop sweating. This can cause body temperatures to rise.</li> <li>• Heat stroke may develop suddenly or may follow from heat exhaustion.</li> </ul>	<ul style="list-style-type: none"> <li>• High body temperature (higher than 41 C)</li> <li>• Any one of the following may indicate heat stroke: <ul style="list-style-type: none"> <li>○ Hot, dry, flushed skin</li> <li>○ Person is weak, confused, upset or acting strangely;</li> <li>○ has hot, dry, red skin;</li> <li>○ a fast pulse;</li> <li>○ headache or dizziness.</li> </ul> </li> <li>• In later stages a person may pass out and have convulsions</li> <li>• Fast breathing</li> <li>• Absence of sweating</li> <li>• Shock</li> <li>• Cardiac arrest</li> </ul>

**Wind Chill** is the perceived decrease in air temperature felt by the body on exposed skin due to wind. It must be considered an additional hazard when working in cold environments. The wind chill table should be posted wherever the wind and temperature recorder is mounted.

### Environment Canada Wind Chill Chart

Actual Air Temperature  $T_{air}$  (°C)

Wind Speed $V_{10\text{ m}}$ (km/h)	5	0	-5	-10	-15	-20	-25	-30	-35	-40	-45	-50
5	4	-2	-7	-13	-19	-24	-30	-36	-41	-47	-53	-58
10	3	-3	-9	-15	-21	-27	-33	-39	-45	-51	-57	-63
15	2	-4	-11	-17	-23	-29	-35	-41	-48	-54	-60	-66
20	1	-5	-12	-18	-24	-30	-37	-43	-49	-56	-62	-68
25	1	-6	-12	-19	-25	-32	-38	-44	-51	-57	-64	-70
30	0	-6	-13	-20	-26	-33	-39	-46	-52	-59	-65	-72
35	0	-7	-14	-20	-27	-33	-40	-47	-53	-60	-66	-73
40	-1	-7	-14	-21	-27	-34	-41	-48	-54	-61	-68	-74
45	-1	-8	-15	-21	-28	-35	-42	-48	-55	-62	-69	-75
50	-1	-8	-15	-22	-29	-35	-42	-49	-56	-63	-69	-76
55	-2	-8	-15	-22	-29	-36	-43	-50	-57	-63	-70	-77
60	-2	-9	-16	-23	-30	-36	-43	-50	-57	-64	-71	-78
65	-2	-9	-16	-23	-30	-37	-44	-51	-58	-65	-72	-79
70	-2	-9	-16	-23	-30	-37	-44	-51	-58	-65	-72	-80
75	-3	-10	-17	-24	-31	-38	-45	-52	-59	-66	-73	-80
80	-3	-10	-17	-24	-31	-38	-45	-52	-60	-67	-74	-81

where

$T_{air}$  = Actual Air Temperature in °C

$V_{10\text{ m}}$  = Wind Speed at 10 metres in km/h (as reported in weather observations)

**Notes:**

1. For a given combination of temperature and wind speed, the wind chill index corresponds roughly to the temperature that one would feel in a very light wind. For example, a temperature of -25°C and a wind speed of 20 km/h give a wind chill index of -37. This means that, with a wind of 20 km/h and a temperature of -25°C, one would feel as if it were -37°C in a very light wind.
2. Wind chill does *not* affect objects and does *not* lower the actual temperature. It only describe how a human being would feel in the wind at the ambient temperature.
3. The wind chill index does *not* take into account the effect of sunshine. Bright sunshine may reduce the effect of wind chill (make it feel warmer) by 6 to 10 units.

#### Frostbite Guide

Low risk of frostbite for most people
Increasing risk of frostbite for most people within 30 minutes of exposure
High risk for most people in 5 to 10 minutes of exposure
High risk for most people in 2 to 5 minutes of exposure
<b>High risk for most people in 2 minutes of exposure or less</b>



---

## Western Canada Mine Rescue Manual

# Chapter 4 Electrical Hazards



---

## OBJECTIVES

This chapter is intended to educate and protect rescuers who are called upon to respond to emergencies involving electrical systems. Upon completion of this chapter, the trainee shall be able to demonstrate competency in:

- Concepts and definitions
- Injuries caused by electrocution and factors affecting severity
- Special considerations for emergencies involving electrical equipment
- Guidelines for responding to emergencies involving electrical equipment

### Introduction

The widespread use of electric power, carried by a vast network of energized wires, has resulted in many injuries and deaths due to exposure to electricity. Many factors influence the severity of electrical injuries. Although high voltages and amperages are dangerous, contact with low voltages can also be fatal. Moisture on the skin decreases the body's resistance and increases the severity of the injury, whereas partial insulation by dry clothing lessens the effect. Electrocution at heights may result in a fall that can further injure the casualty.

### Electrical Installations

Electricity is generated by power plants. This voltage is stepped up for efficient transmission over long distances to substations near the load centres. Transmission lines operate between 69,000 volts and 500,000 volts.

At the substations, voltage is reduced and power is sent through distribution lines to industrial, commercial, and residential customers. These lines operate between 5,000 V and 25,000 V.

Some mines, especially those in more remote locations, have their own on-site power-generating capabilities. These facilities present unique circumstances during emergencies.

## CONCEPTS AND DEFINITIONS

**Voltage** is the difference in electrical potential between two points in an electrical field. It is the force that causes the flow of electricity, and it is measured in volts (V). Because mines require high voltages, **kilovolts** (kV, 1 kV = 1,000 V) are often used to express the difference in electrical potential.

**Current** is a flow of electrical charge. It can be compared to the rate of water in a pipe. Current is typically measured in amperes (A). (1 ampere = 1000 milliamperes (mA)).

- **Alternating Current** (AC) refers to when a current in a circuit reverses polarity or changes direction in current flow 60 times per second (60 Hz).
- **Direct Current** (DC) refers to a current flowing only from positive to negative.

**Resistance** is similar to the effect of friction on the flow of water in a pipe. Water flows more freely in a large pipe than in a small one, and different materials have different resistances to the flow of electricity. Resistance is measured in **ohms** ( $\Omega$ ).

---

**Grounding** is the process of mechanically connecting isolated wires and equipment to the earth, with sufficient capacity to carry the fault current and to ensure the wires and equipment remain at the same potential (same voltage) as the earth (ground).

**Bonding** is the process of joining together two conductors that do not carry currents. These may be two wires, a wire and a pipe, or these may be two pieces of equipment. Bonding is done by connecting all the metal parts that are not supposed to be carrying current during normal operations, thereby bringing them to the same electrical potential. Grounding is still required after bonding as bonding itself does not protect anything.

**Insulators** are materials of high resistance that conduct electricity in such small quantities that it cannot normally be detected. Examples of insulators include glass, ceramic, and porcelain.

**Conductors** are materials of low resistance that conduct electricity in large amounts. Examples of conductors include copper, aluminum, iron, salt water (brine), and most other metals.

**Semiconductors** are materials that have a value of resistance between those of insulators and conductors. Examples of semiconductors include wood, earth, and rubber tires.

**Arcing:** An electrical arc is a sudden release of electrical energy bridging a gap between two conductors. An arc can be extremely hot. Arcing is usually associated with a short circuit, a current interruption at a switch point, or loose terminal.

**Overheating:** Loose connections and overloaded electrical conductors or motors cause overheating. Exceeding the amount of current that conductors and equipment are designed to carry is dangerous and can be avoided by using properly-sized overload and short-circuit protection devices.

**Low Voltage:** Most electrically caused fires originate in equipment operating below 750 V. In the electrical industry, anything below 750 V is commonly referred to as low voltage or secondary voltage.

**High Voltage:** Electricity can arc through the air to a person, tool, or other conductor if they get too close. All rescuers, tools, and equipment including aerial devices and extension ladders must maintain a minimum distance known as the **safe limit of approach**.

Canadian Electrical Code's Safe Limits of Approach	
Voltage of Live Power	Minimum Distance
0–750 V	1 M (3 ft)
750–150,000 V	3 M (10 ft)
150,000–250,000 V	4.5 M (15 ft)
Greater Than 250,000 V	6 M (20 ft)

#### **Voltage Gradient on the Ground**

Because electricity always seeks the path with the least resistance to the ground, electrical systems use conductive grounding rods to ensure that any stray current is returned to earth safely. These rods are typically driven 2.5 m (8 ft) or more into the ground to ensure good contact with the ground. However, if

---

electricity is released onto the surface, such as when a "live" wire lies on the ground, the electricity will fan out from the point of contact.

During a fault to the ground, there is a rippling effect that can be likened to dropping a pebble into calm water. In the pool of water, the wave created at the point of contact gets smaller as it spreads outward. Similarly, in a "pool" of electricity, the energy is at full system voltage at the point of ground contact, but as you move away from the contact point, the voltage drops progressively. This effect is known as **ground gradient**.

### Step and Touch Potential

The ground gradient, or voltage drop, creates two problems: **step potential** and **touch potential**.

Assume that a live downed wire is touching the ground and has created a pool of electricity. If you stand with one foot near the point of ground contact (at x voltage) and your other foot a step away (at y voltage), the difference in voltage will cause electricity to flow through your body. This effect is referred to as **step potential**.

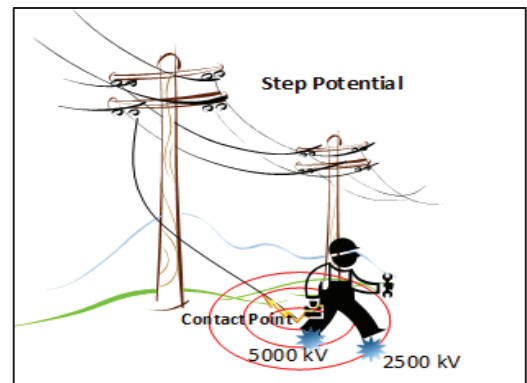

If rescuers find themselves within a ground gradient, they must safely exit it. To do so, keep both feet in contact with each other and hop or shuffle out of the affected area. When shuffling, make certain that the feet are always in contact with one another.

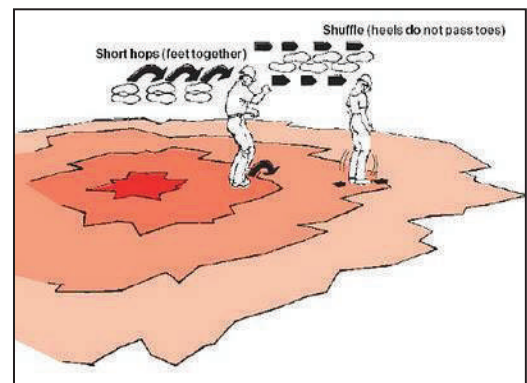

Similarly, electricity will flow through a body if it touches an energized source with the hands, but the feet are at some distance from the source. The difference in potential voltage in this case is referred to as **touch potential**.

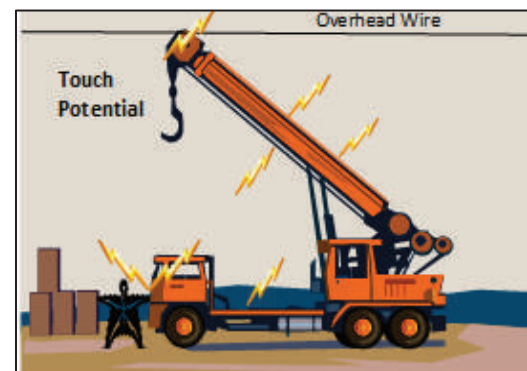

## INJURIES CAUSED BY SHOCKS AND ELECTROCUTIONS

**WARNING: Electricity always seeks the easiest path to the ground. People, who place themselves between any two energized conductors, or any energized conductor and ground, will become part of an electrical circuit that can kill or cause serious injury.**

### Effects of Electricity on the Body

The path electricity takes through the body is critical. For example, current passing through the heart or brain is more life-threatening than current passing through the fingers. The expected effects from just a fraction of this current for a few seconds are illustrated below.

Current level=mA (Milliamperes)	Probable Effect on Human Body
1 mA	Slight tingling sensation.
5mA	Slight shock felt; not painful but disturbing. Average individual can let go. However, strong involuntary reactions to shocks in this range may lead to injuries.
6mA–16mA	Painful shock, begin to lose muscular control. Commonly referred to as the freezing current or “Can’t let go” range.
17mA–99mA	Extreme pain, respiratory arrest, severe muscular contractions. Fractures can occur. Individual cannot let go. Death is possible.
100mA–2000mA	Ventricular fibrillation (uneven, uncoordinated pumping of the heart.) Muscular contraction and nerve damage begins to occur. Burns will occur. Death is likely.
> 2,000mA	Cardiac arrest, internal organ damage, and severe burns. Death is probable.

**Any electrical hazards must be controlled before approaching a casualty. Electrical energy casualties will require prompt and appropriate medical treatment.**

### Factors Affecting Severity of Injury

It is the current (amperage) that kills or injures. But the voltage, which pushes the current through the body, also has an important effect. Persons exposed to household voltages may suffer a muscle spasm and become locked-on to the electrical source until the current is turned off, or until they are dragged clear by the weight of their body falling away from the contact. Relatively long periods of contact with low voltage current cause many electrical fatalities.

At very high voltages, such as from power lines, the casualty is often quickly blown clear of the circuit. This results in less internal damage, such as heart failure, but serious surface burns where the current enters and leaves the body. Exposure to a large electric arc can result in injury from the intense heat or from ultraviolet rays, which can cause serious eye damage.

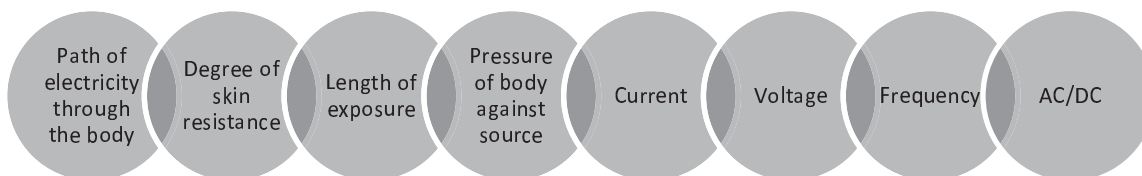



---

## SPECIAL CONSIDERATIONS FOR ELECTRICAL EMERGENCIES

### Combustible Materials

Fires involving electrical equipment often result from the presence of combustible materials. For example, most fires that break out in electrical generating plants originate in fuel systems, oil systems, flammable gaseous atmospheres, combustible dust, accumulated waste material, or in buildings constructed of combustible material.

### Faulty Electrical Equipment

Electricity is safe in normal operating conditions. However, hazards are created when electrical equipment or wires have become faulty due to:

- Wear or other deterioration
- Improper installation
- Inadequate maintenance
- Improper use
- Damage or breakage
- Lightning

Any one of these factors may cause arcing or overheating of electrical equipment.

### Substation and Generator Fires

Substations and generating facilities contain transformers, large quantities of oil, energized electrical equipment and, in some cases, cylinders of compressed gas. Some older transformers still in service might contain polychlorinated biphenyls (PCBs), many of which release toxic by-products when heated.

Upon arrival at a substation or generator fire, rescuers should stand ready to protect adjacent properties. Authorized personnel will inform rescuers when the substation has been made electrically safe. Once electrical energy isolation is completed and locked out, rescuers can then proceed to extinguish the fire.

### Electrical Arc Flash Hazard

An **arc flash hazard** can exist when energized electrical conductors or circuit parts are exposed or are within equipment in a guarded or enclosed condition. The hazard is present when a person is using electrical equipment improperly, or when someone breaches the safe limits of approach. Under normal operating conditions, enclosed energized equipment that has been properly installed and maintained should not pose an arc flash hazard.

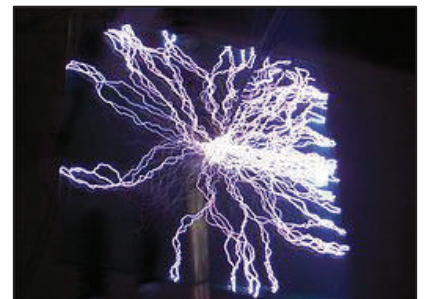







---

## Vehicles in Contact with Live Wires

Emergency Situation	Action to be taken by emergency personnel
A fallen wire lies under a vehicle with occupants...	Do not touch any part of the vehicle. You could be electrocuted, even if you are wearing rubber gloves. Instruct occupants to stay where they are until electrical crews arrive.
The operator is unhurt and can move the vehicle...	Instruct the operator to move the vehicle clear of the wire, and clear of any pools of water which may be energized by the live wire. Make sure you are not in a position to be injured if the wire springs up after being released when the vehicle moves. Make sure no one else is standing in a dangerous location.
A fallen wire lies across a vehicle with occupants...	Do not touch any part of the vehicle. Instruct occupants to stay where they are until electrical crews arrive.
If the operator is injured and cannot move the vehicle...	Instruct the operator to stay in the vehicle until electrical crews arrive.

**Direct contact with power lines is not necessary to pose an arcing hazard as power can arc from the lines to a crane or other piece of equipment.**

## ELECTRICAL HAZARDS ENCOUNTERED BY SPECIFIC WORK GROUPS

Work Groups	Hazards	Photo
Welders	<p>Responders should know all welders use electrical systems to “Weld, Cut, or Braze”. They must be aware of the electrical hazards and take positive steps to eliminate and/or mitigate those hazards.</p>	
Crane Operators	<p>Contact with overhead power lines is a major cause of fatalities in the industry. Electricity can travel from a power line to a worker touching any part of the crane or the load.</p>	
Haul Trucks and Other Heavy Equipment	<p>Tires can explode during or after contact with power lines / lightning.</p> <p>If a vehicle contacts overhead power lines there may be a massive electrical current flowing through the vehicle and its tires:</p> <ul style="list-style-type: none"> <li>• This can cause the tires to explode on contact or could cause the tires to start burning inside. Rescue teams must consider their approach angle, safe distances, and the size of the tire.</li> <li>• This creates a build-up of gases and heat which could cause the tire to explode at a later time, even as much as 24 hours after the incident.</li> <li>• The resulting explosion could potentially injure persons in the proximity with flying debris.</li> <li>• The vehicle should be isolated for a period of time at a safe distance to avoid injury.</li> </ul>	 
Ground Engagement Tools (excavators, dozers, graders, etc.)	<p>Buried power and communication lines pose a hazard to operators of equipment used during trenching and excavation activities. Operators need to be aware of the hazards posed by penetration of energized power lines and take positive steps to eliminate the hazard before digging.</p>	

---

## GUIDELINES FOR ELECTRICAL EMERGENCIES

**Always assume that all electrical wires and equipment are energized until proven otherwise. Mine rescue teams must ensure that energy isolation is complete prior to conducting rescue operations.**

- When arriving at the incident scene, stage response vehicles at a distance that avoids exposure to electrical hazards.
- Control the incident scene to eliminate unauthorized access and prevent exposure to electrical hazards.
- Wait for authorized personnel to isolate power. Use **lock-out/tag-out devices** when working near energy sources as per site-specific isolation procedures.
- Guard against electrical shocks, burns, and eye injuries from electrical arcs.
- Establish an exclusion zone equal to the length of the distance between two poles (i.e., one span) in all directions from downed power lines.
- Be aware that damaged electrical lines can move significant distances by themselves when energized or as a result of the wire's coil memory.
- Be aware that other wires may have been weakened and may fall at any time.
- Exercise caution while raising or lowering ladders, elevated work platforms, and booms near power lines.
- Do not touch any vehicle or apparatus that is in contact with electrical wires.
- Do not use solid or straight water streams on fires in energized electrical equipment.
- Be aware that wire-mesh, chain-link, barbed wire, and steel-rail fences can be energized by wires outside of your field of view.
- Where wires are down, heed any tingling sensation, as this indicates a ground gradient.





---

Western Canada Mine Rescue Manual

# Chapter 5 Gases and Hazardous Atmospheres



---

## OBJECTIVES

Mine rescue teams will find themselves in environments where toxic and hazardous substances pose threats to their health. Being able to identify and respond safely to these substances is a fundamental aspect of mine rescue. Upon completion of this chapter, the trainee shall be able to demonstrate understanding of:

- Terms, concepts, and formulae
- The properties and effects of mine gases

### Introduction

Many gases found in a mine during normal operating conditions can have a harmful effect on the human body if inhaled for a period of time in concentrations above the recognized safe limit.

Emergencies such as fires can emit large quantities of toxic or explosive gases and create an oxygen-deficient atmosphere. The first priority for miners at the time of a mine fire is to protect themselves from these conditions.

## CONCEPTS AND DEFINITIONS

### On The Threshold of Understanding: Toxic Chemicals

Deadly concentrations of toxic gases may be only a few **parts per million (ppm)**. For many of us, 1 ppm is about as hard to visualize as the national debt. The following examples will help grasp what one part per million really represents and also help you think in metric units. One ppm is the same as:

- 1 metre step in 1,000 kilometres
- 1 millilitre per 1,000 litres of liquid
- 1 square centimetre in 100 square metres
- 1 cent in 10,000 dollars

**Threshold limit values (TLVs)** are airborne concentrations of substances and to which most workers may be repeatedly exposed day after day without adverse effect. Because of the wide variation in individual susceptibility, however, a small percentage of people may experience discomfort from some substances at concentrations at or below the threshold limit. A smaller percentage may be affected more seriously by aggravation of a pre-existing condition or by development of an occupational illness.

The categories of TLVs are specified, as follows:

**Threshold Limit Value – Time Weighted Average (TLV-TWA)** is the time-weighted average concentration for a normal eight-hour workday and a 40-hour workweek, to which nearly all workers may be repeatedly exposed without adverse health effects.

**Note:** When TWA is not indicated, refer to the 8-hour TLV.

A **Concentration Equivalent (Ceq)** formulae must be used for shifts longer than an eight-hour workday and a 40-hour workweek. The formula used depends on the jurisdiction in which the mine is located.

---

**Threshold Limit Value – Short Term Exposure Limit (TLV-STEL)** is the concentration to which workers can be exposed for a short period of time without suffering from:

- Irritation
- Chronic or irreversible tissue damage, or
- Narcosis of sufficient degree to increase the likelihood of accidental injury, impair self-rescue or materially reduce work efficiency, provided that the daily TLV-TWA is not exceeded.

The STEL is not a separate independent exposure limit. Rather, it supplements the time-weighted average (TWA) limit where there are recognized acute effects from a substance whose toxic effects are primarily of a chronic nature. STELs are recommended only where toxic effects have been reported from high short-term exposures in either humans or animals.

A STEL is defined as a 15-minute exposure which should not be exceeded at any time during a work day even if the eight-hour time-weighted average is within the TLV.

Exposures at the STEL should not be longer than 15 minutes and should not be repeated more than four times per day. There should be at least 60 minutes between successive exposures at the STEL. A period other than 15 minutes may be recommended when this is warranted by observed biological effects.

**Threshold Limit Value – Ceiling (TLV-C)** is the concentration that should not be exceeded during any part of the working exposure.

#### **Combined Threshold Limit Values**

The air in a mine may contain a combination of different gases, which when combined may cause adverse effects and therefore must be taken into account. When two or more hazardous substances have a similar toxicological effect on the same target or system, their combined effect, rather than that of either individually, should be given primary consideration. The equation for determining the combined TLV is:

$$\frac{C1}{T1} + \frac{C2}{T2} + \dots + \frac{Cn}{Tn} = Dose$$

Where *C* is the concentration and *T* is the threshold limit value.

If *Dose* is greater than 1, the TLV for the mixture has been exceeded.

**Median Lethal Dose (LD 50)** refers to the dose of a toxic substance that would be fatal for 50% of a test population.

**Median Lethal Concentration (LC 50)** refers to how concentrated a toxic substance must be in an atmosphere to be fatal for 50% of a test population.

**Immediately Dangerous to Life and Health (IDLH)** refers to a condition posing immediate danger to life or health, or a condition posing an immediate threat of severe exposure to contaminants. If a concentration of a contaminant is above the IDLH, only positive-pressure breathing apparatus should be used to enter such an atmosphere or to move someone through that atmosphere.

**Airborne particulate** concentrations are generally measured in milligrams per cubic metre of air ( $\text{mg}/\text{m}^3$ ) and gaseous concentrations are measured as parts per million or % by volume.

**Lower and Upper Explosive Limits** refer to the minimum (LEL) and maximum (UEL) concentrations of a gas or vapour in air that will ignite when exposed to an ignition source provided there is sufficient oxygen to support combustion.

**Relative density (vapour density or specific gravity)** is the ratio of the density of a substance to the density of a standard substance under specified conditions. For liquids and solids the standard is usually water. For gases the standard is often air.

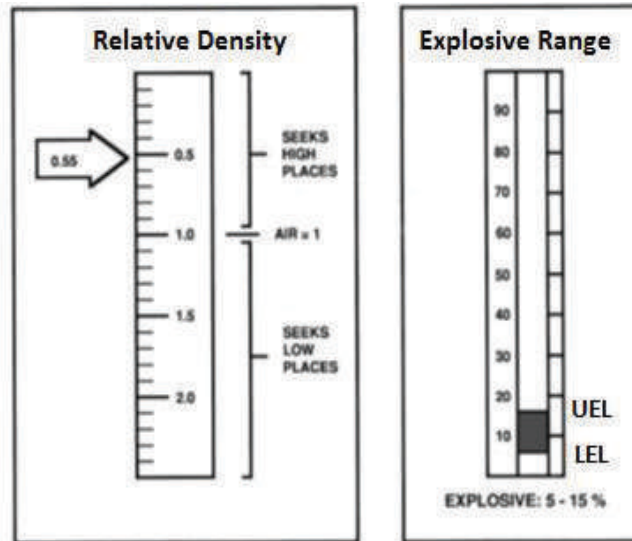

Fig 5.1 Relative density and Explosive range for Methane

**The pH scale** is a means of measuring a substance's acidity or alkalinity. The scale is broken down into 14 degrees. Pure water has a pH of 7. A pH below 7 indicates that a substance is **acidic**, while a pH above 7 indicates that a substance is **basic** or **alkaline**. Both acidic and basic substances are **corrosive**, but the severity increases the further away one gets from a pH of 7.

0	Battery acid, strong hydrofluoric acid
1	Hydrochloric acid secreted by stomach lining
2	Lemon juice, gastric acid, vinegar
3	Grapefruit juice, orange juice, soda
4	Tomato juice, acid rain
5	Soft drinking water, black coffee
6	Urine, saliva
7	"Pure" water
8	Sea water
9	Baking soda
10	Great Salt Lake, milk of magnesia
11	Ammonia solution
12	Soapy water
13	Bleach, oven cleaner
14	Liquid drain cleaner

**Regulatory requirements and site-specific procedures dictate special precautions required for any gases stored or transported in pressurized containers.**



## NAME OF GAS

# Air Gas Mixture (AIR)

## PROPERTIES

Air is colourless, odourless, tasteless and non-flammable. It is a mixture of several gases that, though ordinarily invisible, can be weighed, compressed to a liquid or frozen to a solid. Pure, dry air at sea level contains several gases, in the following proportions by volume %: nitrogen (N<sub>2</sub>), 78.09; oxygen (O<sub>2</sub>), 20.94; argon (Ar), 0.94 and carbon dioxide (CO<sub>2</sub>), 0.03. Traces of other gases, such as hydrogen and helium, are also present. The air in a well ventilated mine seldom shows any depletion of the oxygen content.

## HOW FORMED

Air is the invisible envelope surrounding the earth, in which plants, animals, and human beings live and breathe.

## EFFECTS ON HUMANS

Mine air may be contaminated by the presence of other gases such as carbon monoxide, sulphur dioxide, hydrogen sulphide, methane, oxides of nitrogen and excess carbon dioxide. The presence of these gases may be due to any of the following:

- Blasting or other explosions
- Mine fires
- Diffusion from ore or country rock, as with methane or radon
- Decay of mine timber
- Absorption of oxygen by water or oxidation of timber or ore
- Use of diesel motors underground
- Gas released from thermal water – carbon dioxide, hydrogen sulphide

Except in the case of fire, adequate positive ventilating currents will prevent any dangerous accumulation of these gases. Gases may affect people either by their combustible, explosive or toxic properties, or, if inert, by the displacement of oxygen. The effects may be due to a variety of conditions including:

- **Altitude:** Breathing becomes more laborious due to the decrease in oxygen content as the altitude increases. This is not dangerous unless conditions are extreme or the work arduous.
- **Humidity:** High temperatures with high humidity are very enervating and cause considerable discomfort.
- **Temperature:** High temperatures with low humidity are not dangerous except from the blistering effect of heat.

## Impure Air

Non-toxic gaseous impurities are not dangerous unless they have displaced oxygen to a level below 19.5%. Regardless of the oxygen level, some toxic gases have deadly effects, even in very low concentrations. Effects may be sudden or gradual, depending on the concentration of the impurity.

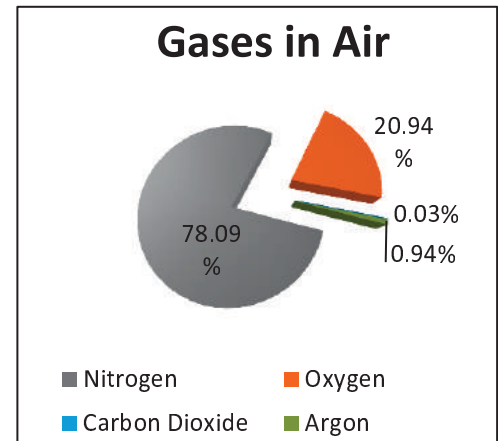

---

---

**NOTE: The Physiological Effects charts included with each gas sheet are general levels associated with the effects, not specific ranges. The data contained comes from many different resource materials. Care has been taken to use the most consistent and recent data possible.**

**NAME OF GAS and CHEMICAL SYMBOL**

## **Acetylene (C<sub>2</sub>H<sub>2</sub>)**

**PROPERTIES:**

Acetylene is colourless, has a faint odour of ether, and is tasteless. Acetylene is a highly flammable hydrocarbon fuel that produces industry's hottest flame (3,260 C/5,900 F) when combined with oxygen in the oxyacetylene process.

Acetylene is very unstable and can become dangerously explosive if compressed above 100 kilopascals (kPa) (15 psi) in the free state. Acetylene cylinders are therefore packed with porous material that is saturated with acetone in which the acetylene is dissolved. Acetylene can thus be safely stored and transported at a pressure of 1,700 kPa (250 psi). Never use acetylene above 100 kPa (15 psi). Acetylene has an explosive range of 2.8%–81%.

**HOW FORMED**

Product of mixing water with calcium carbide

**EFFECTS ON HUMANS**

Can displace oxygen

**OTHER INFORMATION**

Acetylene forms an explosive compound with copper and alloys containing more than 67% copper. The hazard is carefully avoided in the manufacture of welding torches, tips, and regulators.

If an acetylene cylinder has been laid on its side, place the cylinder upright and wait at least one hour before using, as per the Canadian Centre for Occupational Health and Safety.

**Some welders call acetylene "gas" and oxygen "air". This dangerous habit could cause death or injury under certain circumstances. Call all gases by their proper names.**

---

**NAME OF GAS and CHEMICAL SYMBOL**

## **Ammonia (NH<sub>3</sub>)**

### **PROPERTIES**

Ammonia is colourless, has a very pungent odour characteristic of drying urine, and is tasteless. Ammonia (also known as anhydrous ammonia or ammoniac) is a flammable caustic gas with a strong and distinctive smell detectable at concentrations of 1 to 50 ppm. Ammonia has an explosive range of 16%–25%.

### **HOW FORMED**

It is formed by the reaction of nitrogen with hydrogen in the presence of a catalyst. It is stored in commercial cylinders as a compressed liquefied gas. It is corrosive and also explosive when exposed to heat and oxidizing substances. It can also be formed by contact between ammonium nitrate and cement.

### **EFFECTS ON HUMANS**

Ammonia's corrosive qualities will irritate the eyes, nose, throat, lungs, or moist skin and may cause considerable distress. Even brief exposure to concentrations of 5,000 ppm or more may cause rapid death due to suffocation or oedema in the lungs.

### **OTHER INFORMATION:**

Specific clean-up procedures:

- Move the leaking cylinder to an exhaust hood or safe outdoor area for venting. Mark the empty cylinder DEFECTIVE.
- Use a water spray or fog to reduce the gas cloud from a serious leak or spill, but do not aim a water jet directly at the source of the leak.
- If possible, turn the leaking cylinder so that gas rather than liquid escapes. Isolate the area until the gas has dispersed.

Firefighting procedures for fires involving ammonia:

Carbon dioxide and powder extinguishers are suitable for fighting fires in which ammonia is involved. Stop the flow of gas or liquid and move ammonia cylinders from the fire area if it is safe to do so. Use a water spray to keep containers cool but do not direct water at the source of an ammonia leak or a venting safety device. Pressurized containers may explode in a fire, releasing irritating ammonia gas; be prepared by wearing self-contained breathing apparatus. Ammonia is not readily ignited, but explosions of air-ammonia mixtures have occurred, particularly in confined spaces.

<b>Physiological Effects of Ammonia</b>	
<b>NH<sub>3</sub> in the Atmosphere (PPM)</b>	<b>Symptoms</b>
>1	Detectable odor
1–3	Mild irritation of mucus membranes
5–15	Moderate irritation of mucus membranes
30	Chest pain, shortness of breath, coughing
40–60	Fluid in the lungs (oedema), pneumonitis
400	Fatal in 30 minutes
1,000	Fatal in a few minutes

---

**NAME OF GAS and CHEMICAL SYMBOL**

## **Carbon Dioxide (CO<sub>2</sub>)**

**PROPERTIES**

Carbon dioxide is a colourless, odourless gas that when breathed in large quantities may cause a distinctly acidic taste. The gas will not burn or support combustion. Carbon dioxide is heavier than air and is often found in low places and abandoned mine workings.

**HOW FORMED**

Carbon dioxide, an inert gas, is a normal constituent of mine air. It is a product of the decomposition or combustion of organic compounds in the presence of oxygen as well as respiration of humans and animals. The proportion of carbon dioxide in mine air is increased by the process of breathing, by open flame, explosions and blasting, or by escape from thermal water. It is also used as an extinguishing agent and is also released from dry ice.

**EFFECTS ON HUMANS**

Clinical investigations indicate that carbon dioxide influences the respiratory rate. This rate increases rapidly with increasing amounts of carbon dioxide.

<b>Physiological Effects of Carbon Dioxide</b>	
<b>CO<sub>2</sub> in the Atmosphere (ppm)</b>	<b>Increase in respiration</b>
500	Slight
20,000	50%
30,000	100%
50,000	300% & Laborious
100,000	Survivable for only a few minutes

**NAME OF GAS and CHEMICAL SYMBOL**

# Carbon Monoxide (CO)

**PROPERTIES**

Carbon monoxide is a colourless, odourless, tasteless gas that, when breathed in even low concentrations, will produce symptoms of poisoning. Carbon monoxide has an explosive range of 12.5%–74%. It is only slightly soluble in water and is not removed from the air to any extent by water sprays. It is slightly lighter than air.

**HOW FORMED**

Carbon monoxide gas is one of the greatest chemical hazards to humans. It is a product of combustion in normal blasting operations and the operation of internal combustion engines. It is also produced by occurrences such as mine fires or gas explosions. It can be formed wherever organic compounds are burned in an atmosphere with insufficient oxygen to carry the process of burning or oxidation to completion.

**EFFECTS ON HUMANS**

When carbon monoxide is absorbed it reduces the capacity of the haemoglobin for carrying oxygen to the tissues. The affinity of haemoglobin for carbon monoxide is about 300 times its affinity for oxygen. This means that when even a small amount of carbon monoxide is present in the air breathed, the haemoglobin will absorb the carbon monoxide in preference to the oxygen. It is this interference with the oxygen supply to the body that produces the symptoms of poisoning.

Physiological Effects of Carbon Monoxide	
CO in the Atmosphere (PPM)	Symptoms
0–35	No symptoms
36–200	Flu-like symptoms: runny nose, headache
201–800	Dizziness, drowsiness, vomiting in less than an hour
801+	Unconsciousness, brain damage, and death

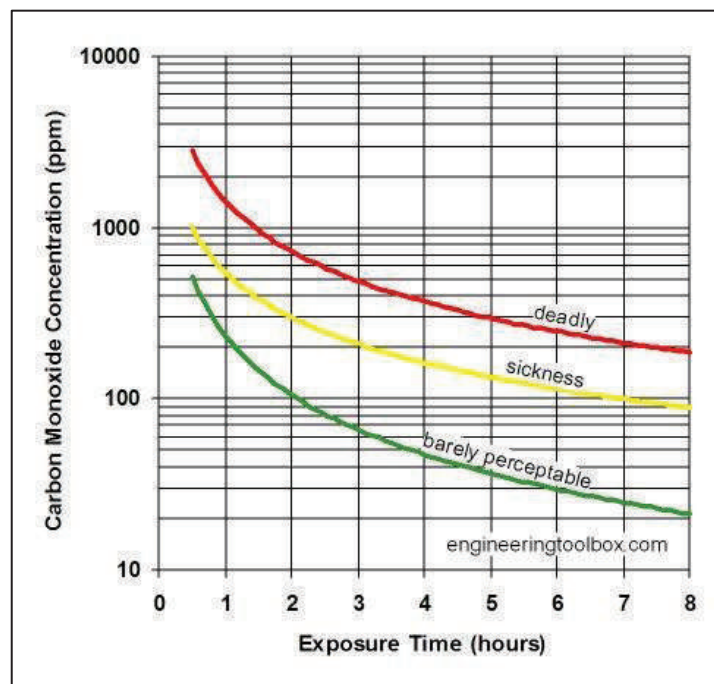

---

**NAME OF GAS and CHEMICAL SYMBOL**

## **Chlorine (Cl<sub>2</sub>)**

### **PROPERTIES**

Chlorine is a heavy, greenish yellow, non-flammable gas that has an odour similar to chlorine bleach and is tasteless. Chlorine is easily liquefied and is supplied commercially as a liquid under pressure in cylinders and larger containers.

### **HOW FORMED**

Electrolysis of common salt and other chemical reactions involving chlorine compounds. Some of its uses include treating potable water and milling processes.

### **EFFECTS ON HUMANS**

Because of its fairly low solubility in water, chlorine is a severe irritant to the eyes, skin, and respiratory system (oedema).

### **OTHER INFORMATION**

Chlorine itself is not flammable, but it may react to cause fire or explosions upon contact with turpentine, ether, ammonia, hydrocarbons, hydrogen, or steel pipes and vessels.

Refer to site-specific procedures for handling and storing chlorine. Only specially trained workers should manage incidents involving chlorine. Special considerations for handling leaking chlorine containers:

- If chlorine is escaping as a liquid, turn the container so that chlorine gas escapes. The amount of gas escaping from a leak is about one-fifteenth the amount of liquid which will escape through a hole of the same size.
- Do not apply water to a chlorine leak.
- Pinhole leaks in cylinders and large containers may sometimes be temporarily stopped by tapered hardwood pegs or metal drift pins driven into the holes. First turn the container so that only gas is escaping. Use extreme care in driving the plug because the wall area surrounding the hole may be thin and crumble. After taking this emergency measure, empty the cylinder as quickly as possible.

<b>Physiological Effects of Chlorine Gas</b>	
<b>Cl<sub>2</sub> in the Atmosphere (PPM)</b>	<b>Symptoms</b>
0–6	Eye irritation
7–15	Throat and lung irritation
16–30	Chest pain, vomiting, coughing, difficulty breathing, excess fluid in lungs (oedema)
430+	Fatal in 30 minutes

---

**NAME OF GAS and CHEMICAL SYMBOL**

## **Hydrogen (H<sub>2</sub>)**

### **PROPERTIES**

Hydrogen is a colourless, odourless and tasteless gas. It is highly flammable. Hydrogen has an explosive range of 4%–74% with as little as 5% oxygen in the air.

### **HOW FORMED**

Hydrogen can be produced when rock is heated to incandescence. It is a product of incomplete combustion or distilling coal. The most common source of hydrogen at mines is battery charging.

### **EFFECTS ON HUMANS**

Hydrogen may cause an oxygen-deficient atmosphere resulting in asphyxiation.

---

NAME OF GAS and CHEMICAL SYMBOL:

## Hydrogen Cyanide (HCN)

### PROPERTIES

Hydrogen cyanide is a colourless, tasteless gas with a distinctive odour of bitter almonds. Many people cannot detect presence by odour therefore the scent alone does not provide adequate warning of hazardous concentration. It condenses to a colourless liquid at temperatures below -26 C. Hydrogen cyanide has an explosive range of 5.6%–40%.

### HOW FORMED

Hydrogen cyanide is formed by the reaction of hydrochloric acid on cyanide compounds, such as potassium/sodium cyanide. It may occur in concentrator areas where cyanide is used as a reagent in the milling of gold ore, and other places where cyanide compounds are used. It may also be released from cyanide-bearing concentrator tailings. A solution of hydrogen cyanide in water is called hydrocyanic acid or prussic acid.

### EFFECTS ON HUMANS

Hydrogen cyanide is a fast-acting and deadly poison that causes paralysis of the respiratory system and chemical asphyxiation. It interferes with the normal use of oxygen by nearly every organ of the body. It is particularly dangerous as it can be absorbed through the skin as well as by inhalation.

Physiological Effects of Hydrogen Cyanide	
HCN in the Atmosphere (PPM)	Symptoms of Exposure
0–20	May detect odour. Minor symptoms.
20–50	Depending on amount and exposure time, may have initially experience restlessness and increased respiratory rate. Other early symptoms may include weakness, giddiness difficulty breathing, heart palpitations, headache. Onset of signs and symptoms is usually rapid after inhalation and may continue for several hours after exposure
>50	Immediately dangerous to life and health (IDLH). Symptoms include nausea, vomiting, convulsions, respiratory failure, unconsciousness.
>110	Can be quickly fatal



---

**NAME OF GAS and CHEMICAL SYMBOL**

## **Hydrogen Sulphide (H<sub>2</sub>S)**

### **PROPERTIES**

Hydrogen sulphide is colourless, tasteless, highly toxic, and highly soluble in water. In low concentrations its distinctive rotten-egg smell is noticeable, but in high concentrations the sense of smell is quickly paralyzed by the action of the gas on the respiratory system and cannot be relied upon as a warning. Hydrogen sulphide has an explosive range of 4.3%–45%.

### **HOW FORMED**

Dust explosions occurring in blasting operations in sulphide ore bodies can create hydrogen sulphide. It is also formed from burning sulphide ores or in the reaction of hydrochloric acid on sulphide concentrations. It may also be released from coal or country rock pockets, or from vegetable matter decomposing in water.

### **EFFECTS ON HUMANS**

Hydrogen sulphide is highly toxic and has neurotoxic effects. It immediately paralyzes the sense of smell and progresses to respiratory paralysis then death. It is an irritant that may cause pulmonary oedema.

<b>Physiological Effects of Hydrogen Sulphide</b>	
<b>H<sub>2</sub>S in the Atmosphere (PPM)</b>	<b>Effects of Exposure</b>
<1	Odour (rotten egg) can be detected
10	No known adverse health effects; respiratory protection required above this limit
20–50	Eye, nose, throat, and lung irritation
50–100	Prolonged exposure can cause a runny nose, cough, hoarseness, and shortness of breath
>100	Immediately dangerous to life and health (IDLH)

---

NAME OF GAS and SYMBOL

## **MAPP – Mixture of Methylacetylene, Propadiene, Propylene, Propane**

### **PROPERTIES**

MAPP is colourless, tasteless, slightly soluble in water and may smell slightly fishy. MAPP has all the best features of acetylene, natural gas and propane, and is extremely safe to use. It is a very stable gas. MAPP has an explosive range of 1.8%–11.7%.

### **HOW FORMED**

Man-made combination of gases stored as a liquid under pressure.

### **EFFECTS ON HUMANS**

MAPP may cause an oxygen deficient atmosphere and in high concentrations may have an anaesthetizing effect. MAPP is a slight irritant to the skin and, due to its high evaporation rate, may cause tissue freezing or frostbite on skin contact with the liquid.

---

**NAME OF GAS and CHEMICAL SYMBOL:**

## **Methane (CH<sub>4</sub>)**

### **PROPERTIES**

Methane is a colourless, odourless and tasteless gas. An odour caused by the presence of other gases such as hydrogen sulphide often accompanies it. Methane is lighter than air and has an explosive range of 5%–15%.

Guidelines for methane in work environments:

- ≥1% methane (20% of the LEL): No blasting or shot firing.
- ≥1.25% methane (25% of the LEL): Isolate electrical circuits.
- ≥2.5% methane (50% of the LEL): All workers are withdrawn from any work.

### **HOW FORMED**

It is formed by the decomposition of organic matter in the presence of water and the absence of oxygen. It may be seen as bubbles in pools of water. It is a component of natural gas. Methane gas may be trapped in hardrock and released through diamond drilling operations. Methane is also produced by decaying timber.

### **EFFECTS ON HUMANS**

Methane may cause an oxygen-deficient atmosphere resulting in asphyxiation.

---

**NAME OF GAS and CHEMICAL SYMBOL**

## **Nitrogen (N<sub>2</sub>)**

### **PROPERTIES**

Nitrogen is a colourless, odourless, tasteless and inert gas.

### **HOW FORMED**

Nitrogen is a naturally occurring constituent of the atmosphere. It is used in industry in either liquid or compressed gas form.

### **EFFECTS ON HUMANS**

Nitrogen itself has no physiological effect on humans. However, increased nitrogen levels may cause an oxygen-deficient atmosphere resulting in asphyxiation.

---

**NAME OF GAS and CHEMICAL SYMBOL**

## **Nitrogen Dioxide (NO<sub>2</sub>)**

**PROPERTIES**

No colour in small concentrations, reddish brown in high concentrations. May smell like blasting fumes. Acidic taste if inhaled in high concentrations. It is one of many oxides of nitrogen.

**HOW FORMED**

Nitrogen dioxide is formed when nitric oxide (NO) is exposed to air, such as in electric arcing, oxy-gas welding, internal combustion engines, and burning or detonating explosives.

**EFFECTS ON HUMANS**

Nitrogen dioxide corrodes the respiratory passages and inhaling relatively small quantities may cause death. Symptoms from low doses of nitrogen dioxide may have a delayed onset. Its effects on the respiratory passages include oedema and swelling. This irritation may be followed by bronchitis or pneumonia, with potentially fatal results.

<b>Physiological Effects of Nitrogen Dioxide</b>	
<b>NO<sub>2</sub> in the Atmosphere (PPM)</b>	<b>Effects of Exposure</b>
60	Minimum causing immediate throat irritation
100	Minimum causing coughing
100–150	Dangerous for even short exposure
200–700	Quickly fatal after short exposure

---

**NAME OF GAS and CHEMICAL SYMBOL**

# Oxygen (O<sub>2</sub>)

**PROPERTIES**

Oxygen is a colourless, odourless and tasteless gas. It is required to support life and combustion.

**HOW FORMED**

Found in the atmosphere as a product of photosynthesis.

**EFFECTS ON HUMANS**

Any reduction from normal oxygen levels affects human physiology. Increased levels of oxygen reduce fatigue, but may have other effects over long periods of time that could occur with the use of an oxygen breathing apparatus. Atmospheres in the workplace should contain at least 19.5% oxygen.

Physiological Effects of Oxygen Deficiency	
% O <sub>2</sub> in the Atmosphere (PPM)	Effects of Exposure
>23 (230,000)	Will accelerate combustion
21 (210,000)	Normal breathing
17 (170,000)	Breathing faster and deeper
15 (150,000)	Dizziness, buzzing noise, rapid pulse, headache, blurred vision.
9 (90,000)	May faint or become unconscious.
6 (60,000)	Movement convulsive, breathing stops. Shortly afterwards, the heart stops.

---

**NAME OF GAS and CHEMICAL SYMBOL**

**Propane (C<sub>3</sub>H<sub>8</sub>)**

**PROPERTIES**

Propane is colourless, odourless but commercially scented, tasteless, and flammable. Propane is a liquefied petroleum gas. Propane vapour is heavier than air. Any escaping gas will seek out low places, such as excavations, which may result in the accumulation and creation of flammable mixtures. Propane has an explosive range of 2.4%–9.5%.

**HOW FORMED**

Propane is extracted from natural and refinery gases. It is compressed into a liquid state and will remain as a liquid when stored under pressure.

**EFFECTS ON HUMANS**

Propane may cause an oxygen-deficient atmosphere resulting in asphyxiation.

**OTHER INFORMATION**

When converting to vapour, liquid propane will expand to about *270 times* its liquid volume. Therefore, escaping liquid gas is more dangerous than vapour escaping from a leak of the same size.

---

**NAME OF GAS and CHEMICAL SYMBOL**

## **Sulphur Dioxide (SO<sub>2</sub>)**

### **PROPERTIES**

Sulphur dioxide is colourless, has an acidic taste and has a strong sulphurous smell with a low odour threshold. Sulphur dioxide is soluble in water. It is a heavy gas and will accumulate in low places.

### **HOW FORMED**

Sulphur dioxide is a gas produced by heating, burning, or blasting sulphide ores. It is also produced in explosions of sulphide ore dust. Some diesel fuels also produce low amounts of sulphur dioxide when burned.

### **EFFECTS ON HUMANS**

Sulphur dioxide may cause noxious effects before it becomes toxic. Irritation of the respiratory tract and lungs will cause oedema.

<b>Physiological Effects of Sulphur Dioxide Exposure</b>	
<b>Concentrations of SO<sub>2</sub> in the Atmosphere (PPM)</b>	<b>Effects of Exposure</b>
0 – 0.25	Mild to severe irritation to eyes, nose and throat
> 0.25	Sulphur dioxide can cause a life-threatening condition from accumulation of fluid in the lungs (pulmonary oedema). Exposure to high concentrations can cause coughing, nausea, vomiting, shortness of breath, tightness in chest, stomach pain and corrosive damage to the airways and lungs (symptoms may be delayed). May cause long term respiratory effects. Skin contact may cause burns, but signs and symptoms may vary (e.g., stinging pain, redness of the skin and blisters). Contact with eyes can cause mild irritation to severe burns.
>100 ppm	Immediately dangerous to life and health (IDLH)



---

## ATMOSPHERIC HAZARDS DURING AND AFTER FIRES

During and following fires, the two greatest hazards to life are carbon monoxide poisoning and oxygen deficiency. The conditions that cause contamination of mine atmospheres are as follows, listed in order of the seriousness of the hazard:

- Carbon monoxide: This gas is always present at the time of a fire and gives little or no warning of its presence.
- Oxygen deficiency: This condition occurs when oxygen is consumed by combustion or chemical reaction and is replaced by toxic or inert gases. Precautions must always be taken against it.
- Explosive gases and smoke: Irritating qualities and obstructs vision
- Methane: This gas is not produced by mine fires or explosions but may cause them. Its presence in a mine during rescue or recovery operations creates a major hazard.
- Sulphur Dioxide: This gas is present when a fire occurs in a sulphide ore body. Because of its irritating qualities, it may give advance warning in low concentrations.
- Other gases: Hydrogen sulphide, nitrous oxides, hydrogen cyanide, etc., are not likely to be encountered but the possibility of their occurrence should be kept in mind. Hydrogen sulphide sometimes indicates the presence of methane.

### Burning Conveyor Belts and Rubber Tires

Polyvinylchloride (PVC)-covered belting is practically non-flammable, but when heated, PVC, synthetic rubber, and neoprene (found in rubber tires) give off chlorine gas. Other gases produced by burning rubber are listed below.

<b>GASES PRODUCED BY BURNING RUBBER, NEOPRENE AND PVC</b>
<b>Carbon Monoxide</b>
<b>Chlorine</b>
<b>Hydrogen Chloride</b>
<b>Phosgene</b>
<b>Sulphur Dioxide</b>
<b>Hydrogen Sulphide</b>
<b>Nitrogen Dioxide</b>
<b>Ammonia</b>
<b>Hydrogen Cyanide</b>
<b>Arsine</b>
<b>Phosphine</b>

### Radiation Sources

One source of radiation is nuclear gauges used for measuring. When responding to an incident involving this source, contact the site Radiation Safety Officer (RSO).

Another source of radiation is radon, a naturally occurring element released into the mine's atmosphere. As it is released, it continues to decay and forms airborne radioactive atoms. If radon levels in an area are very high, breathing protection may be required to reduce radiation exposure. Refer to site-specific safety procedures for all radiation emissions.

**MINE RESCUE GAS CHART – For General Reference Only (non-regulatory)**

Substance	Chem. Symbol	Relative Density Air = 1	Explosive Range %	T.L.V. ACGIH	I.D.L.H. NIOSH	Properties COT = Colourless, Odourless, Tasteless	How Formed (See individual gas sheet for further information)
-----------	--------------	-----------------------------	-------------------	--------------	----------------	--	--

Lighter Than Air	Hydrogen	H <sub>2</sub>	0.07	4–74	Asphyxiant	Not Listed	COT	Incomplete comb. electrolysis of water, battery charging
	Methane	CH <sub>4</sub>	0.55	5–15	YES	Not Listed	COT	Decomposition of organic matter, carbonaceous rock, decaying timber, component of natural gas
	Ammonia	NH <sub>3</sub>	0.60	16–25	YES	YES	Colourless, Strong odour	Reaction of nitrogen & hydrogen in the presence of a catalyst
	Acetylene	C <sub>2</sub> H <sub>2</sub>	0.91	2.8–81	Asphyxiant	Not Listed	Colourless, Distinct odour	Water on calcium carbide
	Hydrogen Cyanide	HCN	0.94	5.6–40	YES	YES	Colourless, Bitter Almond odour	Acid on sodium or potassium cyanide, produced during heat treating of drill steel, may be released from tailings where cyanide was used for mineral recovery
	Carbon Monoxide	CO	0.97	12.5–74	YES	YES	COT	Fires, gas explosions, blasting, incomplete combustion, diesel and gas engine exhaust
	Nitrogen	N <sub>2</sub>	0.97	N/A	Asphyxiant	Not Listed	COT	Constituent of air, Commercial liquid or gas
AIR		1.00	N/A	Nitrogen 78.09 %, Oxygen 20.94%, Carbon Dioxide 0.03%, Argon & Other Gasses 0.94%				
Heavier Than Air	Oxygen	O <sub>2</sub>	1.10	N/A	N/A	Not Listed	COT	Constituent of air, From photosynthesis
	Hydrogen Sulphide	H <sub>2</sub> S	1.19	4.3–45	YES	YES	Colourless, Rotten Egg Odour	Decomposition of some sulphur compounds, blasting sulphide ores, decomposition of vegetable matter in water, hydrochloric acid on sulphide
	Carbon Dioxide	CO <sub>2</sub>	1.53	N/A	YES	YES	COT, Taste in high concentration	Constituent of air, breathing of humans & animals, decomposition or combustion of organic compounds with presence of oxygen
	Propane	C <sub>3</sub> H <sub>8</sub>	1.56	2.4–9.5	YES	Not Listed	COT Commercially Scented	Petroleum distillate
	MAPP	N/A	1.58	1.8–11.7	N/A	Not Listed	Distinct fishy Odour	Commercially manufactured
	Sulphur Dioxide	SO <sub>2</sub>	2.20	N/A	YES	YES	Colourless, Sulphur smell, Acid taste	Heating, burning or blasting sulphide ores, burning of some diesel fuels
	Chlorine	Cl <sub>2</sub>	2.49	N/A	YES	YES	Green yellow, Bleach smell	Principally from electrolysis of salt
	Nitrogen Dioxide	NO <sub>2</sub>	2.62	N/A	YES	YES	Colourless to reddish brown, Acid taste in high concentration	One of the many oxides of nitrogen, associated with burning & blasting, arching, welding, diesel exhaust

Fig 5.1 General gas information for most commonly encountered gases



---

## Western Canada Mine Rescue Manual

# Chapter 6 Rescue Tools



---

## OBJECTIVES

Dozens of different tools are commonly used in mine rescue operations. Upon completion of this chapter, the trainee shall be able to demonstrate competency in:

- Concepts and definitions
- General safety considerations
- Tool classes
- The tools most commonly used in mine rescue

## CONCEPTS AND DEFINITIONS

The type of incident will dictate which tools are used to endeavor to rescue and ensure the safety of trapped and injured worker while minimizing risk to the rescuer and casualty. Tool selection should also account for maintaining and protecting mine property (e.g., to vehicles, infrastructure, equipment) from further damage as well as facilitating the rehabilitation of affected work areas while preserving the incident scene for investigation.

**This chapter is not an exhaustive inventory of every tool that could be encountered on a mine site. Trainees must be familiar with which tools are available at their mine site.**

Rescue tools can be organized into two general categories: hand tools and power tools.

**Hand tools** are tools that require manual force. They extend the range or force of body actions.

**Power tools** are operated by external or internal power sources. They are typically **pneumatic** (air-powered), **hydraulic** (fluid-powered), or **electric** (internal (battery) or external (plug-in) power source).

Tools within these two categories can be grouped into sub-categories according to their function:

- Rotating
- Pushing, Pulling, and Lifting
- Prying and Spreading
- Striking
- Cutting
- Fire Appliances
- Hazardous Materials/Spill
- Energy Sources
- Miscellaneous

## GENERAL SAFETY CONSIDERATIONS

- Safety is the primary consideration for the use of any tool. It avoids accidental injury to rescuers, casualties, and bystanders.
- Always wear the appropriate PPE when operating any tool.
- Training and practice in the proper use and functions of rescue tools is required prior to use.
- Special consideration must be paid to the unique demands of power tools, e.g., combustion, sparking, fumes, noise.
- Adequate lighting is essential to properly operate tools.

- Evaluate the consequences of operation before beginning.
- Examine the tool for damage before each use and keep all tools in good working order.
- Use the tool only for tasks for which it is designed.
- Always follow the manufacturer’s instructions when operating any tool.

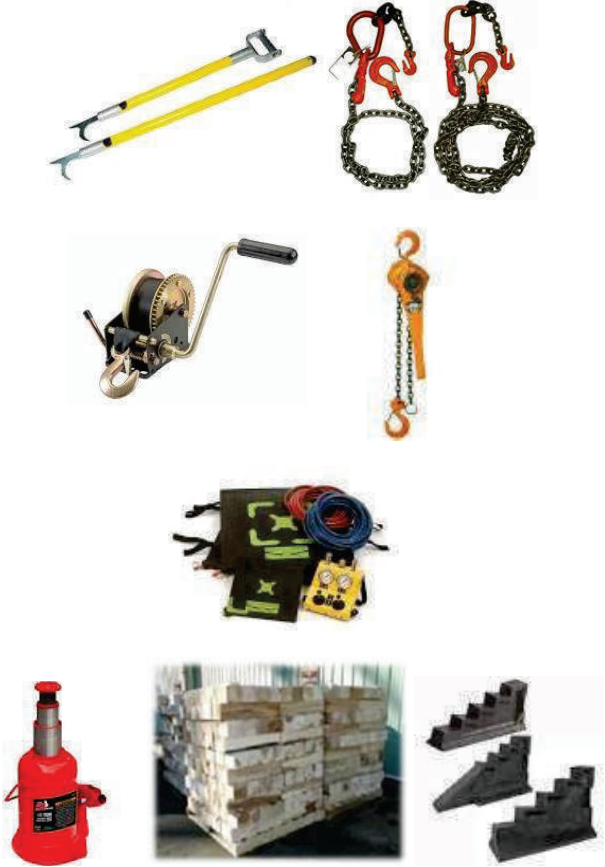
	<p><b>ROTATING TOOLS</b> Used to assemble and disassemble</p> <p>Common rotating tools include (L-R, top to bottom) wrenches, screwdrivers, pliers</p>
	<p><b>PUSHING, PULLING, AND LIFTING TOOLS</b> Use to extend reach or to exert extra force on an object</p> <p>Common tools include pike poles, closet hooks, chains, winches, come-alongs, lifting bags, hydraulic jacks, cribbing and shoring</p> <p>Rope Rescue Equipment (See Ch. 11)</p>



**PRYING AND SPREADING TOOLS**

Used for gaining access

Common tools include pry bars, scaling bars, hydraulic spreaders, rams, claw bars/crow bars, rock splitters, halligans, K tools



**STRIKING TOOLS**

Used to apply impact force or to gain access

Common tools include axes, hammers, sledgehammers, mallets, pick heads, centre punches, and chisels

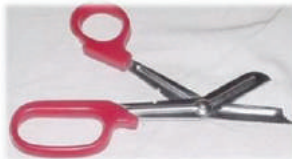

### CUTTING TOOLS

Used to sever an object

Common cutting tools include knives, chain saws, reciprocating saws, rotary saws, hacksaws, cutting torches, bolt cutters, hydraulic shears, scissors, diagonal cutters, air chisels



### ENERGY SOURCES

Provide independent energy in the field

Common tools include power generators, lighting plants, hydraulic power source, compressed air cylinder





**HAZARDOUS ATMOSPHERE AND SPILL TOOLS**

Used to protect responders and help with clean up

Common hazardous atmosphere and spill tools include spill kits, rakes, brooms, shovels, gas detectors, overpack drums, ventilation, respiratory apparatuses, thermal imaging devices, hazardous atmosphere PPE and decontamination equipment



**FIRE APPLIANCES**

Used to assist in fire suppression

Common fire appliances include fire extinguishers, fire hoses, nozzles and pumps





### MISCELLANEOUS TOOLS

Other tools encountered in mine rescue include communication devices, ladders, life lines, confined space equipment (tripods, harnesses, ventilation equipment), tarpaulins, flares, first aid equipment, traffic and hazard control, tape, lock out devices





---

Western Canada Mine Rescue Manual

# Chapter 7 Gas Detection Instruments



---

## OBJECTIVES

Rescue teams can determine the gases and vapours present in an atmosphere using a few different methods and tools. Upon completion of this chapter, the trainee shall be able to demonstrate competency in:

- What gases could be encountered during an emergency response
- Selecting monitoring equipment and methods suitable for the incident
- Practical skills for an effective gas detection program

### Introduction

There are four categories of hazardous atmospheres:

- Toxic
- Oxygen deficiency/Asphyxiating gases
- Explosive/ flammable gases or vapours
- Smoke, aerosols, fumes (particulate contaminants)

**Intrinsic Safety** is a design applied to electrical equipment and wiring for hazardous locations. The technique is based on limiting energy, both electrical and thermal, to a level below that required to ignite a specific hazardous atmospheric mixture.

**All personal protective equipment must be considered before any and all gas testing. Always check that any monitoring equipment or other electrical devices are intrinsically safe.**

## SELECTING GAS DETECTION EQUIPMENT

It is important to select gas detection equipment that fits the specific needs of the incident. Mine rescue gas detection involves the use of **direct-reading instruments** (DRI). These instruments provide information at the time of sampling, thus enabling rapid decision-making.

**All equipment must meet relevant health and safety legislation, standards, and regulations.**

When selecting gas detection equipment, the user should:

- Check for conditions that could interfere with the equipment
  - **Cross Sensitivity:** Sensor's reaction to an interfering gas. The response of a sensor to a gas that is not the target of the sensor.
  - Some gases, such as acetylene, can interfere with the instrument sensor and mask the presence of sulphur dioxide (SO<sub>2</sub>).
  - Other common interferences: Electromagnetic fields, humidity, atmospheric pressure/altitude, low temperatures, saturation and high concentrations.
- Consider performance criteria/specifications of the instrument
  - **Response Time:** Ability to react to its specific gas in the time specified (Ex. 90% of reading in 30 seconds).
  - **Noise/Drift:** How much readings fluctuate when the quantity or concentration of a substance stays the same.
  - **Limit of Detection (LOD):** The lowest quantity or concentration of a substance that the instrument can register within a margin of confidence.
  - **Accuracy:** The degree to which the measurement of a quantity of a substance matches up with that quantity's actual value.

- **Precision:** The degree to which repeated measurements under unchanged conditions show the same results.
- **Dynamic Range:** The ratio between the largest and smallest possible signals. The smallest is the LOD and the largest is sensor saturation.
- **Note:** Follow all manufacturer's specifications for application and use.

## GAS DETECTOR TYPES

**Colorimetric (Tube-style)** indicators measure more than 200 organic and inorganic gases and vapours in the air. The sealed glass tubes are filled with a granular material coated with a chemical that changes colour when it reacts to a particular gas or vapour.

- **Before Use:** Refer to manufacturer's instructions for the particular tube type.
  - Perform a pump leak test.
  - Ensure the direction arrow is oriented toward the pump.
- **Operation:** A portable pump draws a known volume of air through a detector tube designed to measure the concentration. The colour change is then read on a scale printed on the tube.
- **Considerations:** Measurement accuracy, limits of detection, interferences, temperature/humidity, shelf life, time period for which the colour stain is stable after sampling.



*Drager (L) and Gastec (R) colorimetric tubes*

Readings from a short-term indicator tube should be compared to the appropriate short-term exposure limits, such as TLV-STEL and TLV-C.

- **Tube Storage and Shelf Life:**
  - Tubes have a shelf life. These expiration dates are printed on the box.
  - Store properly by avoiding excessively low or high temperatures and direct sunlight.
- **Advantages:**
  - Operation with one hand.
  - Low weight and simple operation.
  - Always ready for use (no batteries).
  - Tubes for more than 200 different gases and vapours.
  - Printed measuring scale on the tubes provide immediate reading of the result.
  - Low maintenance.
- **Limitations:**
  - Tubes and pumps are manufacturer-specific.
  - No alarm system, therefore not recommended for continuous monitoring
  - Dependent upon operator's interpretation of results
  - Application can require longer periods of time in atmospheres for results to appear (up to several minutes)
  - Limited shelf-life
  - Only accurate within +/- 20%
  - Many cross-sensitivities

- Range of application is dependent on humidity and temperature
- Requires proper storage, handling, and disposal
- Common types of detectors include Drager, Gastec

**Drager CMS**

This variety of gas tube tester follows the same chemical reaction principles. The major differences are:

- Small tubes are contained within a plastic chip with a bar code identifier
- Battery operated pump and tube reader
- Display screen indicating gas being tested, range, sampling duration status and actual reading



The chip has 10 individual sample tubes. Each tube can only be used once. The tester scans the chip when inserted into the reader and indicates the gas and range for which the chip is designed.

**Electronic gas detectors**

An electronic gas detector is a complex system that includes a sensor(s) surrounded by sensitive electronics, alarms (visual, audible, vibrating), a battery and a display. All electronic gas detectors must meet regulated manufacturer standards. Electronic gas detectors are available as single, multi-gas, stationary (non-portable), and specialized units.

- **Advantages:**
  - Multi-gas detectors use separate sensors for oxygen and combustible atmospheres.
  - They can register multiple toxic gases in the same hand-held monitor.
  - Many models have interchangeable-sensor capabilities.
  - Will provide low-level and high-level alarms.
  - Accidental power-off protection: requires the power-off button to be held continuously for at least 3–5 seconds.
  - Many are capable of internal data-logging
  - Portable field docking stations are also available for several models
  - Can have an internal motorized pump or a diffusion monitor with attachable pump that allow the instrument to be used in a variety of applications including confined space entry or to measure from greater distance or height
  - More accurate than colorimetric tubes – accurate within +/- 10%
- **Limitations:**
  - Sensor sensitivity and response to gas will degrade over time; Limited shelf life
  - Gases recognized are sensor-specific
  - Requires time to perform a pre-use procedure
  - Sensors and batteries have a finite life
  - Environmental conditions such as temperature, humidity, dust, dirt and rough handling all contribute to premature sensor degradation

<p><i>BW GasAlert Quattro</i></p>	<p><i>Industrial Scientific Ventis MX4</i></p>	<p><i>Drager MX</i></p>

Typical Life Span of Various Sensor Types	
Oxygen sensors	1–5 years
Catalytic bead combustible gas sensors	3–5 years
Electrochemical toxic gas sensors	1–4 years (depending on type)
Infrared gas sensors	5–10 years
Photoionization gas sensors	2–4 years

## PRACTICAL SKILLS FOR GAS DETECTION

### Atmospheric sampling

The operator performing the sample tests is responsible for:

- Following all manufacturer’s specifications and guidelines
- Making sure that proper sampling techniques are performed due to the stratification of gases that may be present
- Proper sampling: the operator must sample prior to entry, prior to re-entry, and continuously while work is being completed.
- During underground exploration, gas testing should be performed at intersections or where conditions change.
- Sampling at the top, middle, and bottom of a space must be done in accordance with manufacturer specifications.
  - Sample every 1–2 metres (3–7 ft) due to the weights of gases. Some are lighter than air (methane), some are slightly lighter (carbon monoxide), and some are heavier than air (chlorine).

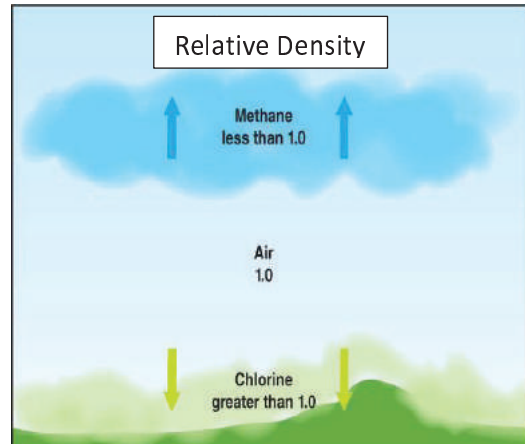

### Bump Testing and Calibration

The most important elements of gas detector maintenance are **function (“bump”) testing** and **calibration**. These tests can be done either automatically via a docking station or manually.

**Functional (“bump”) testing** involves a brief exposure of the monitor to a known concentration of gas(es) for the purpose of verifying sensor and alarm operation.

- Manufacturers recommend that a bump test be performed on every instrument prior to each day’s use.
- Bump tests are not measures of the instrument’s accuracy.
- Any time an instrument fails to respond properly during a bump test, a full calibration should be completed successfully prior to use.



*Docking stations used for bump tests*

---

### Steps for Gas Detector Operation

1. Visually inspect for damage and contamination
2. Turn on instrument in good atmosphere and check battery level
3. Zero the instrument
4. Bump test (functionally check) instrument
5. Clear the peaks if applicable

### Bump Test Procedure

This check is performed by applying a known concentration of gas to verify sensor performance and alarm operation. Following the simple steps below will aid you in performing your bump check.

1. Turn the instrument on and warm-up
2. Zero the instrument
3. Apply calibration gas
4. Allow sensors to respond to calibration gas
5. Verify proper alarm function
6. Remove gas and allow the monitor to clear
7. If any of the sensors fail to respond, remove from service

**Calibration** ensures that detectors perform properly. The process uses a calibration gas with a specific concentration.

- Refer to manufacturer's recommended protocols for calibration.
- It is recommended to perform full instrument calibration using **calibration gas(es)** monthly to ensure maximum accuracy.
- Establishes a point of measurement accuracy
- Provides insight into the condition of the sensors in the instrument
- Adjusts the readings to account for changes due to sensor degradation

**Calibration Gases** are certified and traceable mixtures of gas concentration. Calibration gas cylinders are identified by:

- Gases and Concentrations
- Part Number
- Expiration Date

Follow manufacturer's recommendations when using regulators for disposable gas cylinder and disposing cylinders.





## Western Canada Mine Rescue Manual

# Chapter 8 Respiratory Protective Equipment



---

## OBJECTIVES

Selecting the right protective equipment can mean the difference between life and death when responding to incidents in dangerous environments. Upon completion of this chapter, the trainee shall be able to demonstrate competency in:

- The hazardous respiratory environments encountered in mine rescue work
- Breathing apparatus concepts
- Limitations and safety features of breathing apparatus
- Recharging and hydrostatic testing of compressed gas cylinders

**Refer to manufacturer's guidelines and site-specific procedures for a comprehensive overview of care, use, specifications, and handling of breathing apparatus.**

### Introduction

People who are exposed to a dangerous atmosphere may not be aware that the danger exists nor of the need to protect themselves. Proper and adequate ventilation is the best solution to a dangerous atmosphere. (An exception to this rule is when fire is involved.) Proper respiratory equipment must be used if a mine rescue team cannot ventilate an area and lives or property are at risk.

Oxygen content can reach dangerous levels in hazardous scenarios, such as in:

- Incidents involving fire
- Confined spaces, including buildings, manholes, tunnels, vaults, chemical tanks, oil tanks, storage bins, silos, equipment, and sumps
- Mine workings

Hazardous atmospheres:

- Toxic gases or vapours
- Oxygen deficiency/ asphyxiating gases
- Explosive/flammable gases or vapours
- Smoke, aerosols, fumes (particulate contaminants)

**The lungs and respiratory tract are more vulnerable to injury from hazardous atmospheres than any other part of the body. Inhaling heated gases may cause oedema (fluid collection) in the lungs, which can cause death by asphyxiation. If the air is heated or moist, the damage can be much worse. The tissue damage from hot air is not immediately reversible by introducing fresh, cool air. When taken quickly into the lungs, it may cause a serious decrease in blood pressure and failure of the circulatory system.**

---

## APPARATUS CONCEPTS

Mine rescue teams use both open-circuit and closed-circuit breathing apparatus.

In a **non-self-contained breathing apparatus**, oxygen from the atmosphere is drawn through a filter to the rescuer's breathing apparatus. In environments in which carbon monoxide is present, there must be adequate oxygen in the atmosphere for a non-self-contained breathing apparatus to function properly.

In a **self-contained breathing apparatus**, breathable air is supplied from a cylinder or released as a product of a chemical reaction that occurs in a component of the apparatus.

In an **open-circuit apparatus**, exhaled air is released into the surrounding atmosphere.

In a **closed-circuit apparatus**, exhaled air is recirculated within the system.

### Positive Pressure versus Negative Pressure

The apparatus will deliver breathable oxygen/air to the wearer under **positive pressure**. A positive pressure system will maintain an internal pressure higher than the external pressure.

The advantages of positive pressure:

- Reduces the potential for external atmospheric toxins (smoke, gases) to penetrate into the system, i.e. if the facepiece seal is broken.
- No added breathing effort is required by the wearer (unrestricted).

A **negative pressure** system's internal pressure is lower than the external pressure.

All makes and models of breathing apparatuses have manufacturer's instructions for **donning** (putting the apparatus on) and **doffing** (taking the apparatus off). Rescuers must train to the manufacturers' procedures of the models used on their site.

### Air-Purifying Respirators (APRs) (non-self-contained, open-circuit)

APRs remove contaminants in the air by filtering out particulates (e.g., dusts, fumes, mists), gases, and vapours. They require an adequate amount of oxygen (i.e., 19.5%) in the atmosphere to be used as they do not create or supply oxygen for the wearer. They have a limited protection factor. Cartridge versions are colour-coded for their respective atmospheric contaminant.



*The masks come in a variety of forms, including (from L-R) disposable, half-face cartridge and full-face cartridge models.*

**Fit tests shall be performed for all mask type respirators. Ensure compliance with local regulations, standards, and legislation.**

---

## SELF-RESCUERS (non-self-contained, open-circuit)

### MSA W65

This is a respirator strictly designed for self-rescue to protect the wearer against carbon monoxide gas. It is small and easily carried on the underground miner's belt.

The MSA Model W65 is sealed with nitrogen. If the seal is broken, the unit should be removed from service because the chemicals in the apparatus deteriorate. Users should always examine their self-rescuers for damage before use.



### Operation

- Air is drawn in through the bottom of the self-rescuer and passes through the coarse-dust filter bag.
- The air then passes through a fine-dust filter in the bottom of the canister.
- The air then passes through a drying agent that removes excess moisture that reduces the effectiveness and deteriorates the Hopcalite. The Hopcalite is not consumed in the reaction as it is a catalyst.
- The air flows through the Hopcalite, which causes a catalytic reaction changing the carbon monoxide to carbon dioxide, creating heat in the process.
- The air, which can be dangerously hot, passes through a heat exchanger to be cooled.
- When exhaled, the air again passes through the heat exchanger and out through a check valve, which does not allow air from the outside back into the respirator. The heat exchanger incorporates both the outside atmosphere and exhaled breath to cool the inhaled air.

The W65 self-rescuer will:

- Require at least 19.5% oxygen in the air
- Function in an environment with no more than 95% humidity
- Protect the wearer against 1% (10,000 PPM) carbon monoxide for one hour
- Generate heat when exposed to higher levels of carbon monoxide, thereby shortening the unit's duration. Wearers must be in a respirable atmosphere before removing the unit.
- Have a service life of 10 years and a shelf life of 15 years when properly stored
- Require testing as per manufacturer's specifications

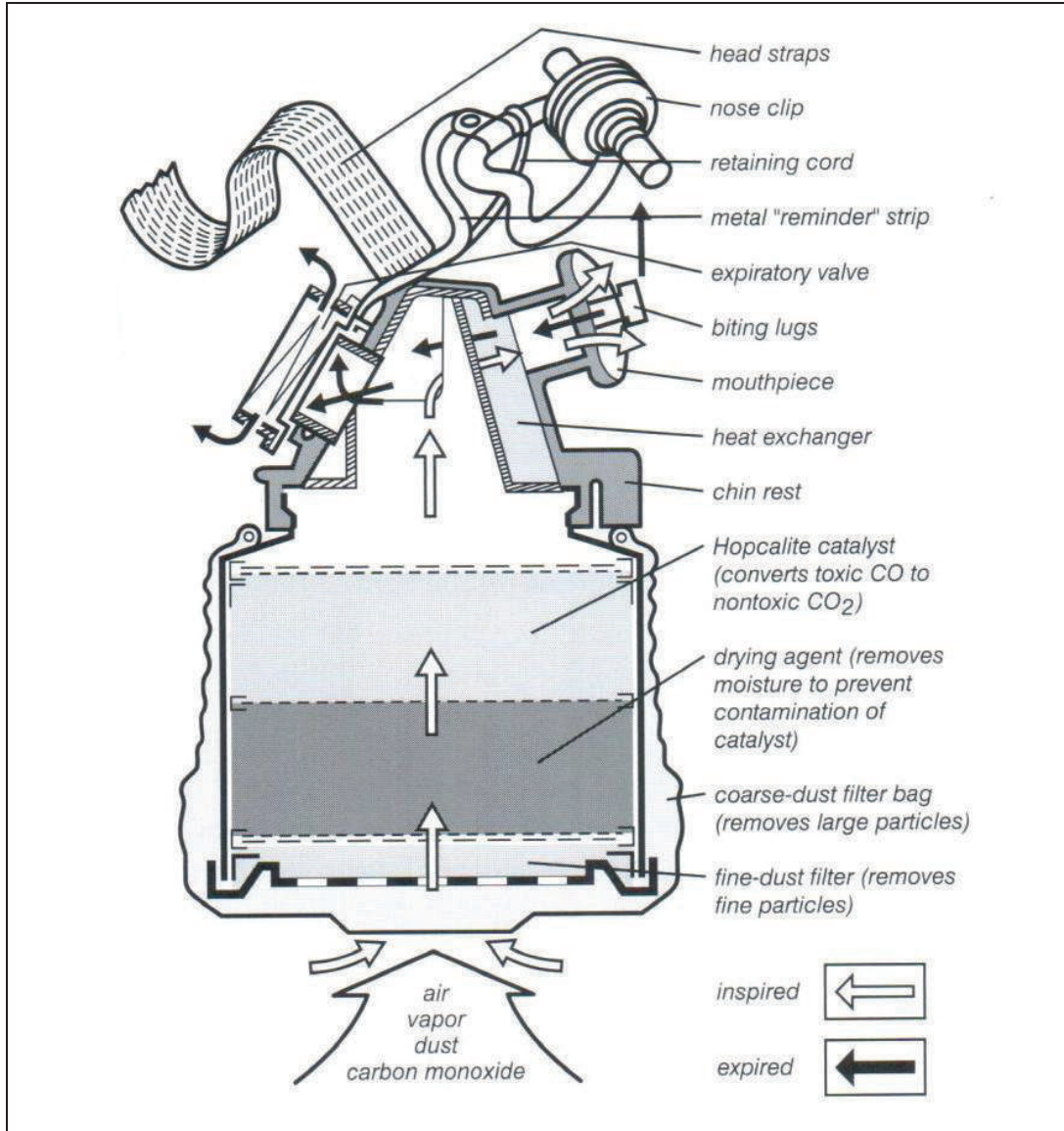

Fig 8-1: How a Self-Rescue functions

---

## SELF-CONTAINED SELF-RESCUERS (SCSR) (Closed Circuit, Self-Contained)

**Oxygen-generating self-rescuers** are designed strictly for self-rescue and to function completely independent of the surrounding atmosphere.

### Operation

- Oxygen is released by the chemical reaction of moisture from the exhaled breath mixing with the potassium superoxide ( $KO_2$ ). This reaction produces heat. A second reaction takes place between the newly created potassium hydroxide and the carbon dioxide from the exhaled breath, which retains/absorbs the carbon dioxide.
- The oxygen is inhaled from the breathing bag, which also serves as a breathing air reservoir.
- A heat exchanger is built into the breathing tube to cool the air before inhalation.
- A quick-start system covers the immediate oxygen requirements of the user until the chemical of the canister becomes activated.



A number of oxygen generating self-rescuers are available on the market today. Some include:

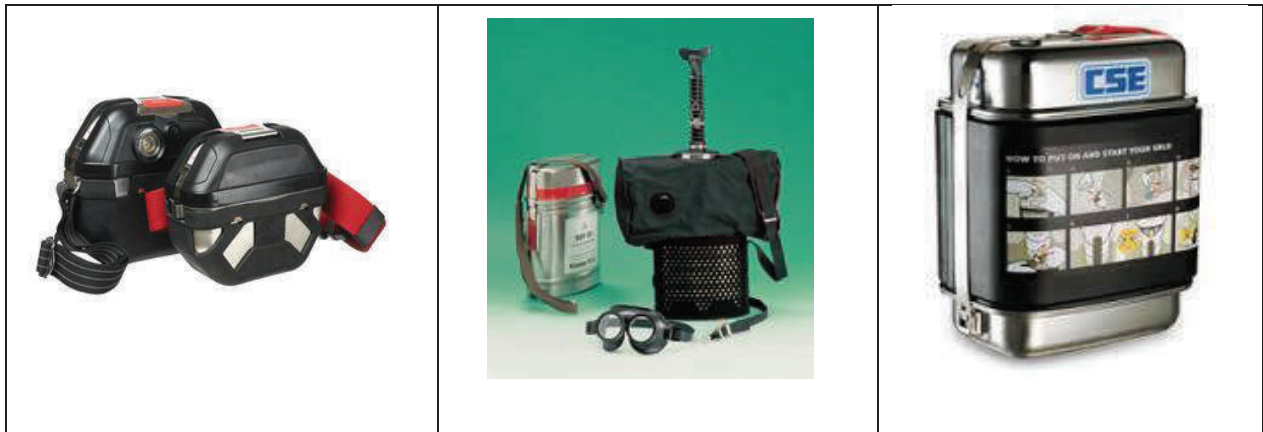

*From L-R: Drager Oxy 3000/6000, Drager Oxy SR 90 and CSE Self-Rescuer Long Duration*



---

## CLOSED-CIRCUIT BREATHING APPARATUS (CCBA)

### (Closed circuit, self-contained, positive pressure, re-breather)

A CCBA's main functions are to absorb carbon dioxide and provide oxygen. CCBAs also recycle the unused oxygen from the wearer's exhaled breath. The recycled air is enriched with oxygen from a compressed oxygen cylinder prior to inhalation.

The positive pressure inside the facepiece protects the wearer from a potentially toxic environment. Modern CCBAs maintain positive pressure by using springs on the breathing bag/chamber and a demand valve when the internal volume of oxygen in the system has decreased.

The increased duration for the wearer (rated up to four hours) allows CCBAs to be used in incidents at both surface and underground mines.

Two common positive pressure CCBAs are:

- Dräger – PSS BG4
- Bio Marine - BioPak 240R



*Dräger PSS BG4*



*Bio Marine BioPak 240R*

---

## SELF-CONTAINED BREATHING APPARATUS (SCBA) (Open Circuit, Self-Contained, Positive Pressure)

SCBAs protect the wearer from hazardous atmospheres by providing breathable air.

Several manufacturers build SCBAs for emergency response and industrial use. There are many models of the control configuration but the basic components and operating principles remain the same.

Open-circuit SCBAs use filtered, compressed air. Most open-circuit systems have two regulators: a first-stage regulator to reduce the pressure of the compressed air in the cylinder and a second stage regulator to reduce it even further to a level just above atmospheric pressure. This air is then fed to the facepiece via a demand valve which is activated by inhalation. When the wearer exhales, the breath exits the facepiece via the exhalation valve to the outside atmosphere thus making it an open circuit. SCBAs have purge/bypass valves for emergency situations.

The four major components of the SCBA are:

- **Backpack assembly:** Designed to hold the air cylinder on the rescuer's back.
- **Regulator:** Reduces the cylinder pressure to flow and pressure levels required for inhalation.
- **Facepiece (mask):** Designed to deliver low-pressure air from the regulator into the mouth and nose of the rescuer. It may also provide some protection from facial burns and contact of smoke and fire gases with the eyes.
- **Air cylinder:** Designed to store a quantity of breathable air under pressure. Depending on construction and size, cylinders may be rated for 30–90 minutes at pressures between 2,216–5,500 psi.

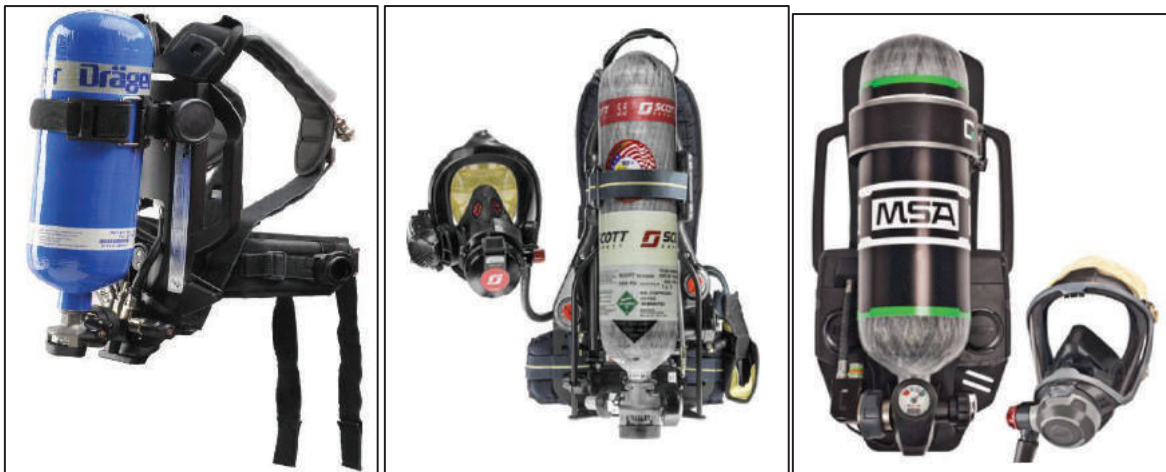

*Dräger PSS 7000, Scott Safety Air Pak X3, MSA G1 SCBA*

**Rapid Intervention Crew/Company Universal Air Connections (RIC UACs)** allow teams to directly attach two air cylinders of any kind to provide air to SCBAs worn by casualties or other rescuers when their supply is low. It is not for quick charging, buddy-breathing or any other unapproved use. If the unit has a RIC connection, it is a standard fitting that is dedicated for emergency use: the Rapid Intervention Crew/Company Universal Air Connection (RIC UAC), NFPA 1981 (2013 edition).





---

### Personal Alert Safety System (PASS)

A **PASS** device is used by the wearer of an SCBA as a safety alarm with a high volume siren if the wearer remains motionless, such as when the wearer has collapsed or is trapped (usually set at pre-alarm when motionless; full alarm of motionless for 30 seconds). It can also be triggered manually. The loud noise provides a location for the rescue personnel to follow. NFPA-compliant SCBA models have the PASS system built into the unit. It is activated automatically when the SCBA air is turned on. Some non-built-in models have a key which turns on the device. The key is then given to the person in charge of team entry before the SCBA team enters a building or structure.



The duration of an SCBA's air supply is based on a number of factors:

- The user's level of exertion.
- The user's physical condition.
- The degree to which the user's breathing is affected by excitement, fear or other emotions.
- The degree of training or experience.
- The type of apparatus.
- The purity of the compressed air (possible presence of carbon dioxide)
- Work at pressures above or below normal atmosphere

### CYLINDER TESTING AND CHARGING

#### Recharging Compressed Air Cylinders

In a **cascade storage system**, several large cylinders are used to bring a small cylinder up to a desired pressure. This is achieved by always using the supply cylinder with the lowest usable pressure first, then the cylinder with the next lowest pressure, etc. A cascade system may be connected to a purification system and air compressor approved for breathable air (CSA Standard Z-180.1-00).



Breathing air cylinders may also be charged directly from an approved breathable **air compressor** or compressor/storage tank configuration.



#### Recharging Oxygen Cylinders

Oxygen cylinders are recharged by transferring oxygen from large-capacity medical-grade oxygen cylinders via high-pressure pump.

**Hydrostatic testing** involves pressurizing a cylinder above its operating pressure to established safety standards to ensure durability of the cylinder over time. The frequency of hydrostatic testing for a compressed cylinder depends on the material and model used.





---

## Western Canada Mine Rescue Manual

# Chapter 9 Oxygen Therapy



---

## OBJECTIVES

Oxygen therapy is administered to assist a casualty's breathing. Mine rescuers must know when and how to use it. In some jurisdictions, oxygen therapy is included as part of first aid training. Upon completion of this chapter, the trainee shall be able to demonstrate competency in:

- Safe practices for oxygen storage, transport, and use
- Recognizing when to use oxygen therapy
- The benefits of oxygen therapy
- The components and assembly of oxygen-therapy equipment
- Administering oxygen therapy
- Calculating duration based on flow from an oxygen cylinder

**Oxygen under high pressure can dangerously lower the flash points and ignition temperatures of petroleum products.**

## SAFE STORAGE, TRANSPORT, AND USE

Following these guidelines for medical oxygen cylinders will help prevent incidents.

### Storage

- Ensure the equipment is clean and in good working order. Check that connections are tight and that controls operate freely.
- Keep cylinders secure at all times.
- The valve protection cap must be in place to protect it from damage whenever large-capacity cylinders are in storage.
- Store all cylinders in a cool, well ventilated, specifically designated place.
- Keep oxidizers, corrosives, and combustibles well separated.
- All cylinders are subject to hydrostatic testing as per manufacturer's specifications.

### Transport

- Cylinders must be secured and capped when being transported.
- Never use a cylinder as a roller or support.

### Use

- Strictly enforce no smoking or open flame when in use. Post signage when practicable, such as in first aid rooms.
- When changing cylinders, open valves slowly and check for leaks.
- While in use, always keep cylinders secure and well away from heat and flame.
- If a leaking cylinder cannot be corrected by tightening the valve, it must be clearly tagged and taken outside to a safe location away from ignition sources, open flame, and petroleum. Secure the cylinder and allow the pressure to bleed completely. The clearly labelled cylinder must be returned to the supplier for repair. Never ship a leaking cylinder.
- All cylinders must be refilled by a qualified person.

---

## WHEN TO USE OXYGEN THERAPY

Oxygen is essential to normal cell function and life itself. Any condition that affects the supply, exchange or transport of oxygen between the atmosphere and the body's cells results in **hypoxia**, a condition defined as inadequate oxygenation of the body tissues.

Supplementary oxygen given during pre-hospital treatment of injuries may significantly improve a casualty's recovery and even the chances of survival. Oxygen therapy is not a substitute for clearing the airway. More extensive training is required to use advanced techniques.

The body needs a continuous supply of oxygen but is unable to store it. Any casualty with the following history, signs, and symptoms will be suffering from hypoxia:

- Pale, cool, clammy skin (shock)
- Cyanosis (blue lips, earlobes or fingernails)
- Shortness of breath (dyspnea) or absence of breath
- Problems with heart function
- Blood loss (internal or external)
- Loss of consciousness
- Extensive burns
- Crush injuries
- Spinal cord injuries
- Allergic reactions
- History of serious trauma, even if there are no obvious injuries
- Nausea and vomiting
- Headache
- Agitation, irritability or confusion
- Drowsiness
- Pregnant casualties

## BENEFITS OF OXYGEN THERAPY

The benefits of oxygen therapy include:

- Increased oxygen supply to the brain, reducing loss of the central nervous system and maintaining control of vital body functions
- Increased oxygen supply to the heart
- Reduced work load on the heart by enriching the oxygen load in the blood, thus reducing the volume of blood that must be pumped
- Stabilized rate and depth of breathing
- Reduced movement of an injured chest will reduce the pain associated with attempts to breathe
- Enriched oxygen content of the air reaching the lungs in the event of partial airway obstruction
- Improved gaseous exchange within lungs congested with fluid (oedema or pneumonia) or particulate by providing more oxygen in the limited volume
- Improved gaseous exchange at the tissue level
- Improved muscle tone, particularly within artery walls
- Generally reduced pain and anxiety

Improvement in the casualty's condition may be indicated by:

- Improved skin colour, temperature, and condition
- Reduced breathing effort
- Stabilized pulse rate
- Reduced pain
- Reduced anxiety, apprehension and restlessness
- Improved level of consciousness

---

## Casualties with Chronic Breathing Problems

People with ongoing or **chronic obstructive pulmonary disease** (COPD) are chronically short of breath and have difficulty breathing. People at the severe stages of this condition are rarely found in a working environment. If providing first aid and oxygen therapy is needed, administer as one would to any other casualty but monitor breathing very closely. If required, reduce flow rate but do not stop oxygen therapy once it has been started.

## OXYGEN THERAPY EQUIPMENT

### The Oxygen Therapy Unit

An oxygen therapy unit has three main components: an **oxygen cylinder**, a **regulator**, and a **delivery tube with a facemask**. Portable units also require a carrying case designed to protect the unit.

### Oxygen cylinders

Medical-grade oxygen (approximately 99% oxygen) is supplied as a compressed gas at 2,000 psi in a variety of standard cylinder sizes. The sizes of cylinders are:

- D (412 L)
- E (682 L)
- M (3,540 L)
- K (6,900 L)

**Note:** A “+” sign stamped at the top of the cylinder indicates that pressure can be increased by 10% to 2,200 psi.

Whatever the size of the cylinder used, they are subject to the requirements of hydrostatic testing. The hydrostatic test date is stamped on the cylinder. A five-pointed star stamped at the top of the cylinder indicates that the hydrostatic test date has been extended an additional five years, and then must be tested every 10 years afterward.



*Cylinder markings*

D and E cylinders have a pin-indexed medical post outlet with a valve operated by a purpose-specific wrench. Others have a special CGA-540 oxygen threaded outlet and a hand valve. Both connections are designed to be unique and prevent inadvertent connection to any gas other than oxygen.

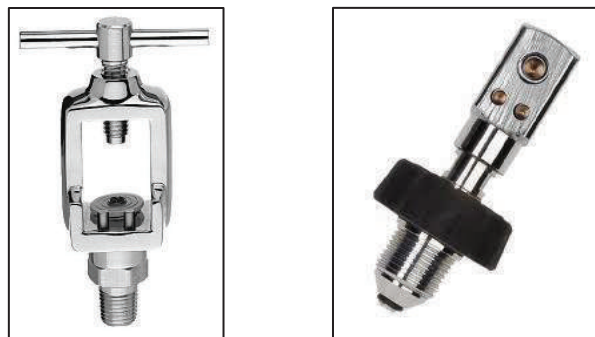

*Pin-indexed medical post outlet (L), threaded outlet (R)*

---

## Pressure Regulators

The regulator assembly has two purposes:

- Reduces the pressure of oxygen delivered from the cylinder to between 40 and 70 psi.
- Regulates the rate of flow (in litres per minute or Lpm) of the delivered oxygen.

The regulator assembly attaches to the cylinder with a yoke containing corresponding pins that fit the medical post and a screw-clamping device. Cylinders with a threaded connection are attached via a corresponding female thread on the regulator assembly. Adaptors are available to attach threaded and yoke-type connections together.

The adaptor used to fit a yoke-type regulator assembly onto a threaded cylinder can be particularly valuable in a major emergency situation. Using these adaptors will prevent gases other than oxygen from being connected.



## Oxygen Mask and Delivery Tube

There are several models of delivery masks available. Delivery tubes are included with the masks. All but the one-time-use simple mask require more extensive training.





## CAREvent

To use this device for oxygen therapy, follow the same steps as one would for the normal oxygen therapy unit. The only difference is that a 3,000-psi Drager BG4 cylinder can be used. The delivery hose and mask used with the normal oxygen therapy unit will work on this regulator.

The handheld resuscitator can also be used for oxygen therapy on a breathing casualty. The device will act in the “on demand” mode much like a self-contained breathing apparatus (SCBA). As the casualty inhales, a valve opens allowing the oxygen to flow into the face piece or nose cup.

Follow these steps to prepare the handheld resuscitator for use:

1. Ensure oxygen flow adjustment is set at zero
2. Connect the supply cylinder to the regulator
3. Connect the resuscitator delivery hose to the regulator
4. Connect the delivery hose to the resuscitator
5. Attach the resuscitator to the face piece or nose cup
6. Turn oxygen supply cylinder on
7. Place face piece or nose cup on casualty (Adjust straps accordingly)

**Note:** All connections should be “finger” tightened only

**This manual will not describe the functions the CAREvent® DRA handheld rescuer can provide for a non-breathing casualty. Please refer to site specific training and always follow the manufacturer’s recommendations.**

		
<p>Oxygen delivery hose and mask connected to regulator with BG4 oxygen cylinder. (Ready for “normal” oxygen therapy delivery)</p>	<p>Oxygen delivery hose, CAREvent® resuscitator and face piece connected to a DSS outlet on regulator with oxygen cylinder</p>	<p>Oxygen regulator for use with a CAREvent® resuscitator</p>



---

## INSPECTING CYLINDERS AND ASSEMBLING COMPONENTS

### Inspecting

- All components must be visually inspected for damage and contamination before use. If there are any deficiencies noted, tag the component and remove it from service.
- Look for an in-service tag or markings denoting cylinder status.
- Check hydrostatic testing stamp on the cylinder as per manufacturer's guidelines.

### Assembling

- Certain types of cylinders come with a plastic breakaway strap over the new gasket. There is also a metal version with a rubber centre that can be used more than once. Ensure that the gasket does not get doubled by removing the old gasket. If it is not removed, alignment problems can arise.
- Secure the cylinder in an upright position.
- Point the aperture in a safe direction away from people or ignition hazards.
- The cylinder must be quickly opened and closed, or "cracked" to ensure there are no contaminants in the aperture.
- As the yoke is positioned on the medical post, check that the gasket is in place and that the pins on the yoke are aligned with the holes in the post (pin indexing).
- Tighten the screw clamp to secure the regulator, *hand-tightened only*.
- Check that the regulator flow control is fully off before opening the cylinder. (In some models, this requires turning counter-clockwise.)
- Open the cylinder valve slowly to stabilize the gauge and then continue to open one full turn.
- Conduct **leak test**:
  - Close the cylinder valve
  - Observe the gauge for drops in pressure for five minutes
  - Open the cylinder valve
  - Observe for gauge movement
  - If there is any drop in the pressure reading, re-tighten the regulator to the cylinder and repeat the test
  - If there is no drop in pressure, close the cylinder, bleed off the pressure in the regulator using the flow control
- Unit is now field-ready and should be securely stored in a designated area.

## ADMINISTERING OXYGEN

Observe the following steps and precautions when administering oxygen:

- No smoking or open flame must be strictly enforced.
- Ensure face mask and tubing are attached to the regulator assembly. Open the cylinder valve gently and slowly.
- Turn the flow control on the regulator to the desired flow rate.
- Allow the oxygen to flow for several seconds to clear any foreign material from the hose and mask.
- Ask the casualty if they have had oxygen therapy while reassuring the casualty about the use and benefits of oxygen therapy prior to administering.

- If the casualty is apprehensive, have the casualty hold the mask near their face if possible until they are comfortable with it. Once comfortable, the elastic strap can be placed behind the casualty's head.
- All casualties requiring oxygen therapy should receive oxygen a constant flow rate of 10 litres per minute unless travel time will deplete the supply.
- Document the start time, flow rates, and any effects on the casualty.

**Never leave a casualty who is not fully alert alone with an oxygen mask secured to their face, even if the casualty is in the lateral or recovery positions. If they vomit, the airway may not clear itself.**

## SHUT DOWN PROCEDURE

When oxygen therapy is complete, follow these steps:

- Shut off the flow on the regulator.
- Note the remaining cylinder pressure. Change the cylinder as per on-site operating procedures.  
**Note:** 200 psi is commonly considered empty.
- Close the main cylinder valve.
- Re-open the flow valve and bleed off pressure in the regulator until the gauge(s) read zero.
- Close the flow valve.
- Replace the face mask and delivery tube with a new unit and ensure all components are ready for use.
- If changing a cylinder or removing a regulator, bleed off the residual pressure in the regulator and dis-assemble.

## OXYGEN CYLINDER DURATION

The rescuer administering the oxygen must ensure the oxygen supply will last for the duration of casualty care. For example, to quickly approximate the duration for a D cylinder (400 L) based on the flow rate used:

1. Divide cylinder pressure (psi) by 100
2. Multiply by:
  - 3.0 for 6 litres per minute (Lpm)
  - 2.5 for 8 litres per minute (Lpm)
  - 2.0 for 10 litres per minute (Lpm)

<b>Oxygen Cylinder Duration – Rule of Thumb Calculations</b>				
<b>“D” Cylinder 400 L of Oxygen</b>				
<b>CYLINDER PRESSURE (psi)</b>	<b>Divided by 100</b>	<b>FLOW (Lpm) 6 (x3)</b>	<b>FLOW (Lpm) 8 (x2.5)</b>	<b>FLOW (Lpm) 10 (x2)</b>
2000	20	60 minutes	50 minutes	40 minutes
1500	15	45 minutes	37.5 minutes	30 minutes
750	7.5	22.5 minutes	18.75 minutes	15 minutes

## Using The Cylinder Factor Method

Note: Safety factor minus (-) 500 psi

CYLINDER SIZE	FACTOR
D	0.16
E	0.28
M	1.56
H-K	3.14

Calculation: Cylinder pressure times (x) factor

Divided by flow (Lpm) = minutes

Example: D size Cylinder with pressure of 2000 psi x Factor 0.16 = 320

Divided by flow 6 litres per minute = 53.33 minutes

The charts below show the durations for various pressures and flow rates for E, M, and K cylinders.

Oxygen Cylinder Duration "E" Cylinder 682 L of Oxygen			
PSI	6 Lpm	8 Lpm	10 Lpm
2000	1 hr, 53 minutes	1 hr, 23 minutes	1 hr, 8 minutes
1500	1 hr, 25 minutes	1 hr, 3 minutes	51 minutes
1000	56 minutes	42 minutes	34 minutes
500	28 minutes	21 minutes	17 minutes

Oxygen Cylinder Duration "M" Cylinder 3,540 L of Oxygen			
PSI	6 Lpm	8 Lpm	10 Lpm
2000	8 hr, 40 minutes	5 hr, 51 minutes	4 hr, 40 minutes
1500	6 hr, 30 minutes	4 hr, 14 minutes	3 hr, 23 minutes
1000	4 hr, 20 minutes	2 hr, 36 minutes	2 hr, 15 minutes
500	2 hr, 10 minutes	59 minutes	47 minutes

Oxygen Cylinder Duration "K" Cylinder 6,900 L of Oxygen			
PSI	6 Lpm	8 Lpm	10 Lpm
2000	17 hr, 30 minutes	13 hr, 0 minutes	10 hr, 30 minutes
1500	13 hr, 0 minutes	9 hr, 50 minutes	7 hr, 50 minutes
1000	8 hr, 45 minutes	6 hr, 30 minutes	5 hr, 15 minutes
500	4 hr, 20 minutes	3 hr, 15 minutes	2 hr, 35 minutes





## Western Canada Mine Rescue Manual

# Chapter 10 Fire



---

## OBJECTIVES

Fire poses major hazards in the rescue and treatment of casualties. Burning structures and equipment must be addressed efficiently to rescue trapped and injured people, as well as to mitigate damage to infrastructure. Upon completion of this chapter, the trainee shall be able to demonstrate competency in:

- Components of personal protective equipment used in fire rescue
- Fundamental characteristics of fire behaviour
- Fire classes, phases, and hazards
- Fire extinguisher classifications, types, and agents
- Special conditions such as ventilation, equipment fires, and BLEVEs

**The information contained within this chapter in no way prepares or certifies the rescuer to perform interior structural firefighting. Always operate within your scope.**

## PERSONAL PROTECTIVE EQUIPMENT

Bunker gear (turnout gear) is the protective clothing that is required to perform fire rescue. This gear needs to be researched prior to the purchase to ensure that it meets the current applicable standards and site requirements. Fire-rated rescue clothing consists of:

- **Helmet:** Protects the head from injury.
- **Protective Hood (balaclava):** Protects parts of the face that are not covered by the collar or helmet.
- **Bunker pants and coat:** Will protect the body from heat, cuts, and abrasions.
- **Gloves:** Protect the hands from heat, cuts, and abrasions.
- **Bunker boots:** Protect the feet from cuts and abrasions from the top and from the bottom.
- **Eye protection:** Protects the wearer's eyes from foreign matter.
- **Hearing Protection:** Protects the ears from excessive noises.
- **Respiratory Protection:** Protects against heated gases as well as toxic and oxygen-deficient atmospheres.
- **Personal Alert Safety System (PASS):** Built into a breathing apparatus or attached to a rescuer.



## Care, Cleaning, and Storage of PPE

- Manufacturer's guidelines must be followed to ensure proper use, storage, and handling.

**All equipment used must meet relevant health and safety legislation, standards, and regulations. During an incident, rescuers may be exposed to biological, chemical, electrical, and fire hazards. Care should be taken to reduce exposure from contaminated PPE during and after an incident.**

## FIRE BEHAVIOUR

Fundamental to a mine rescuer's safety is a basic grasp of the physics and chemistry of a fire.

### States of Matter

There are three states of matter: solid, liquid, and gas/vapour.

Two factors that can change the state of matter are **heat** and **pressure**.

When substances are heated, they tend to change from the solid to the liquid state and then to the gas or vapour state. When substances are subjected to pressure, they tend to change from gas or vapour to liquid and then to solid. Materials as a rule will not burn while in their solid or liquid states. Materials must first change to gas or vapour and then burn.

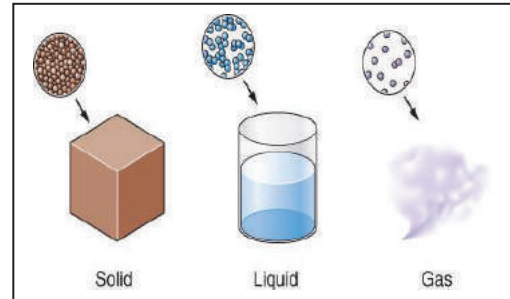

### Factors Affecting Fire Behaviour

Solid fuels have definite size and shape. The surface area of a solid fuel in relation to its mass is a primary consideration for the mine rescuer. The larger the surface area for a given mass, the more rapid the heating of the fuel and the process of pyrolysis will be. The physical position of a solid fuel is also important. If a solid fuel is in a vertical position, the fire will spread more rapidly than if it is in a horizontal position.

**Pyrolysis** refers to the decomposition of organic material at high temperatures in the absence of oxygen. During pyrolysis, the material is heated to a point that both its physical state (e.g., solid) and chemical composition change at the same time. It usually produces gases, vapours, and particulates.

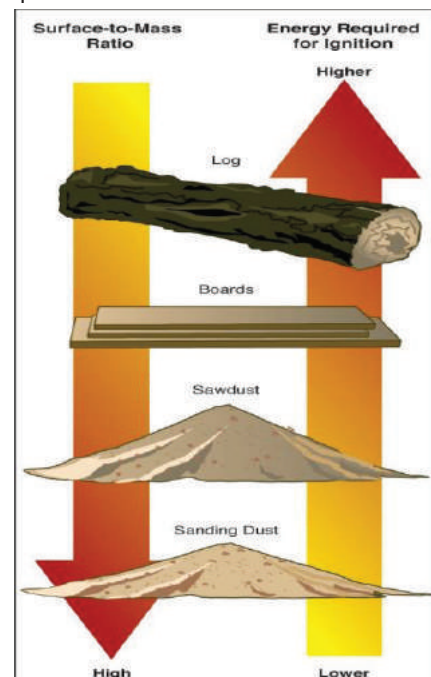
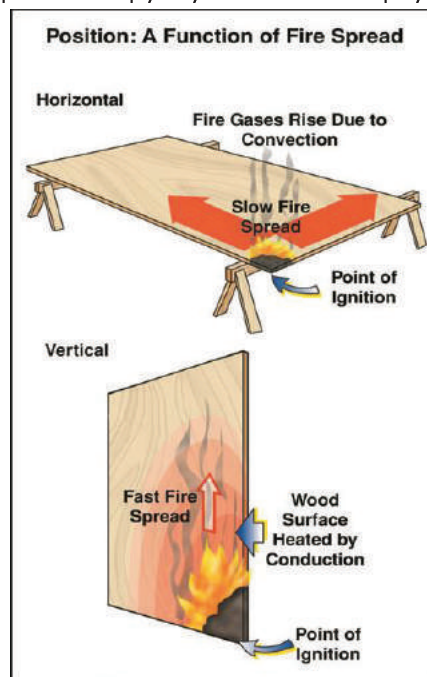

---

## Liquid Fuels

Liquid fuels have physical properties that increase both the difficulty of extinguishment and the hazards to personnel. Liquids will assume the shape of their container. When a spill occurs, the liquid will assume the shape of the ground and will flow and accumulate in low areas. The density of liquids in relation to water is often referred to as **specific gravity** (water = 1). Liquids with a specific gravity less than one are lighter than water. Those with a specific gravity greater than one are heavier than water. Most flammable liquids have a specific gravity of less than one. Hydrocarbon liquids, as a rule, will not mix with water.

## Gases and Vapours

Gases and vapours tend to assume the shape of their container but have no specific volume. If the **vapour density** of a gas or vapour is less than that of air (air = 1), it will rise and tend to dissipate. If a gas or vapour is heavier than air, it tends to hug the ground.

## Requirements for Burning

Fire is a chemical reaction known as combustion. It is defined as the rapid oxidation of combustible material accompanied by a release of energy in the form of heat and light.

## Fire Triangle

The three-sided figure of the fire triangle describes the necessary components to create a fire. When oxygen, heat, and fuel in proper proportions combine they create a fire. If any one of the three elements is removed a fire cannot exist.

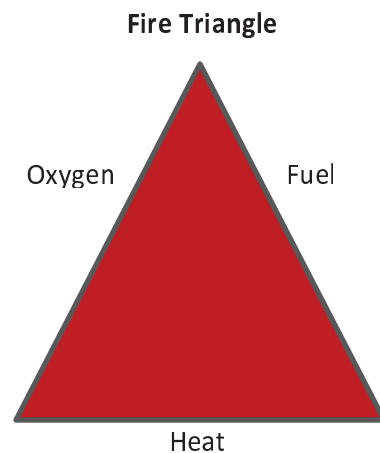

## Fire Tetrahedron

Some chemicals and materials will ignite and burn in a manner that cannot be explained completely by the use of the fire triangle. Some questions that defy explanation under this theory are:

- Why will calcium and aluminium burn in a nitrogen atmosphere, in the absence of oxygen?
- Why do some fuels burn more rapidly when subjected to radioactive emanations (gas)?
- Why do flames react with certain sonic vibrations and electrically charged particles?

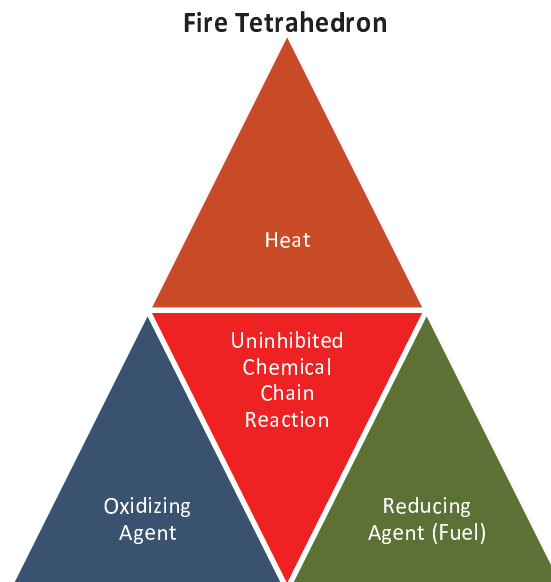



---

These questions can be answered by using the **Fire Tetrahedron**. One of the four components serves as the base and represents the chemical chain reaction. The removal of one or more of the four components will make this tetrahedron incomplete and result in extinguishment of the fire. This theory has not done away with the fire triangle. It has simply added a fourth condition.

The four components of the tetrahedron are:

**Reducing Agent (Fuel):** In the tetrahedron, fuel is defined as “a material that can be oxidized”. The term “reducing agent” references the fact that fuel reduces an oxidizing agent.

**Oxidizing Agent (Oxygen):** The term “Oxidizing agent” explains how some materials, such as sodium nitrate and potassium chlorate (which release their own oxygen under certain conditions), can burn in an atmosphere free of any outside source of oxygen. For example, zirconium dust can be ignited in carbon dioxide without oxygen being involved.

Examples of oxidizing agents are:

Oxygen	Nitric Acid	Chlorates
Hydrogen Peroxide	Sulphuric Acid	Chromates
Fluorine	Manganese Dioxide	Nitrates
Chlorine	Lead Dioxide	Bromine

**Temperature (Heat):** Temperature refers to heat as a quantity of energy. Heat is energy in disorder and temperature is the measure of the degree of that disorder.

**Uninhibited Chemical Chain Reaction:** This chain reaction refers to self-sustaining combustion that continues when heat from the fire radiates back to the fuel, even if the original ignition source is no longer present.

In the burning of either liquid or solid fuels, the vapours, which are distilled off and carried into the flame, contain atoms or molecules that have not been consumed in the initial burning process. These liberated particles may have an electrical charge that either attracts other particles or repels them.

This area, between vapour or gases and the visible flame, is called **flame interface**. Immediately above this area, oxygen molecules exist in sufficient number to produce energy reactions, which create light in the form of flames. This area is fed by the oxygen drawn into the fire as air currents move into the void created by the rising heated vapours or gases.

This process continues throughout the flame. The molecular structure of the material is broken down, and the released atoms combine with other radicals and elements which are drawn into the process to form new compounds, which are again broken down by the heat.

The final by-products then escape the flame in the form of smoke and steam. Since carbon is one of the elements most difficult to ignite, most of the visible smoke consists of unburned carbon particles. This is not a step-by-step process. All of the steps occur simultaneously in varying degrees of intensity throughout the flame.

## Extinguishment

Based on the fire tetrahedron, there are four methods of fire suppression:

- Remove the reducing agent
- Exclude the oxidizing agent
- Reduce the temperature
- Interrupt the chemical chain reaction

### Interrupting the Chemical Chain Reaction

Vapourizing liquid and dry chemical agents extinguish fire more rapidly than the same quantity of other smothering agents. When these extinguishing agents are added to a fire, they release atoms that combine with the molecules involved in the chemical chain reaction. The new molecules formed by this process do not combine with the oxygen in the air that keeps the fire burning, thereby interrupting the chain reaction.

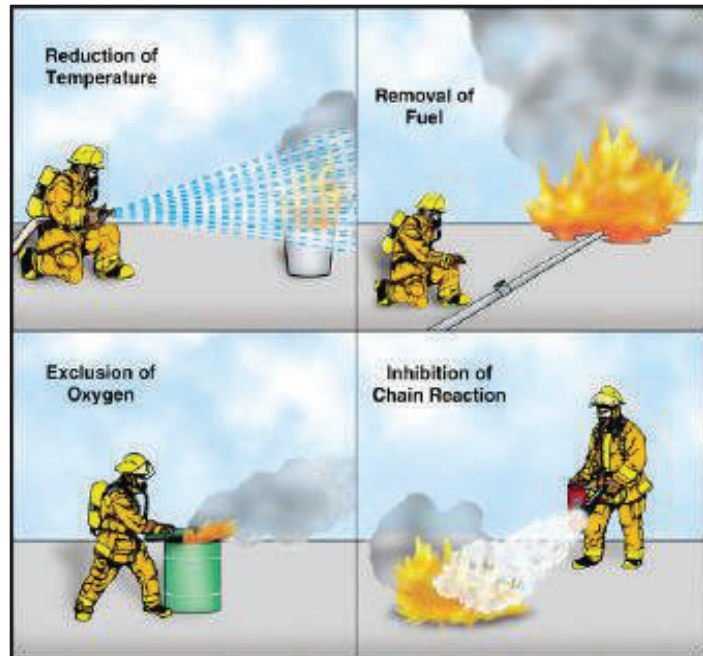

## CONCEPTS AND DEFINITIONS

### Ignition Temperatures

**Auto-ignition Temperature** is the temperature at which a material will ignite *spontaneously*, independent of an external ignition source.

**Flash Point** is the lowest temperature at which fuel will give off enough vapours to ignite when exposed to an external ignition source.

**Fire Point** is the temperature at which a liquid fuel will produce vapours sufficient to support combustion once ignited. The fire point is usually a few degrees above the flash point.

**Ignition Temperature** refers to the minimum temperature to which the material must be heated to initiate self-sustained combustion independent of an outside heating source.

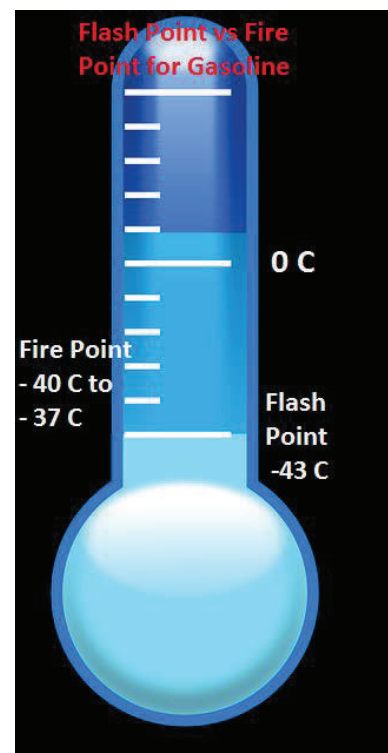

---

## Sources of Ignition

**Adiabatic compression** involves compressing a liquid or gas to produce heat. This heat is generated by molecules running into one another and against the sides of the container. A flammable substance compressed quickly enough can raise the temperature to the substance's ignition point.

**Spontaneous heating** occurs when the temperature of a given substance rises without any external heat source present. Heat is given off by oxidation, but in most circumstances it dissipates harmlessly. However, if three conditions are present, spontaneous heating can lead to ignition:

- The material in question insulates more heat than is being dissipated
- Heat production is great enough to reach the ignition temperature
- Enough air is present to support combustion

Examples of such circumstances are bunched-up oily rags and charcoal piles.

**Hypergolic mixtures** are normally fuels used to propel missiles or rockets. These liquids are designed to ignite once in contact with another hypergolic mixture and do not require an external ignition source.

**Friction sparks** are created when two hard surfaces touch one another with sufficient force. One of the surfaces is usually metal. These sparks can ignite any flammable gases and vapours present.

## Sources of Heat

As the temperature of a substance rises, the motion of the molecules increases and becomes more rapid. Heat, as energy, is a measure of molecular motion in a material. Because molecules are constantly moving, all matter contains some heat regardless of how low the temperature is. The speed of the molecules increases when a body of matter is heated. Anything that sets the molecules of a substance in motion produces heat in that material. The sources of heat energy generally encountered in mine rescue are:

- Chemical heat energy
- Electrical heat energy
- Mechanical heat energy

**Chemical heat energy** is generated when combustible material absorbs heat from a source of ignition. It is the most common source of heat energy in combustion.

**Electrical energy** can lead to combustion by releasing heat through arcing, induction, or resistance to the flow of an electrical current. Static electricity can also produce a spark that is capable of igniting flammable vapours and gases.

**Mechanical heat energy** is produced by either compression or friction. Two materials moving against one another create friction, which releases heat and/or sparks. Compression creates heat when pressurizing gas in a container.

## Transmission of Heat

Heat can travel throughout a burning building by one or more of three methods: **conduction**, **convection**, and **radiation**. Heat tends to move from a hot substance to a cold substance.

**Conduction** involves transfer of heat from one body to another by direct contact or by an intervening heat-conduction medium. Speed of transfer is dependent on the conductivity of the material.

Good heat conductors include copper, aluminum, and iron. Poor heat conductors include masonry, wood, fibrous materials, and air, liquids, and gases.

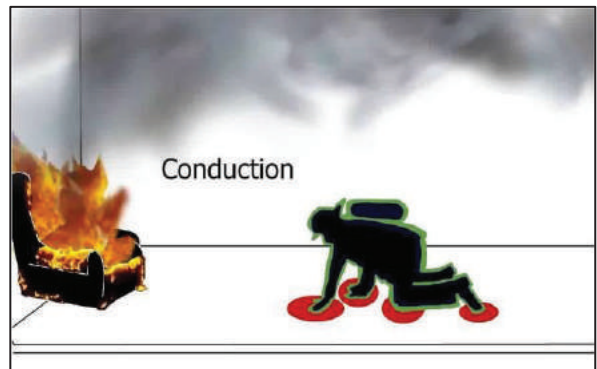

**Convection** is the transfer of heat by the movement of air or liquid. When liquids and gases are heated they begin to move within themselves. As heated air expands and rises, cooler air takes its place at the lower levels. Convection heat currents are generally the cause of heat movement from floor to floor, from room to room, and from area to area. The spread of fire by convection influences the positions for fire attack and ventilation more than any other method of heat transmission.

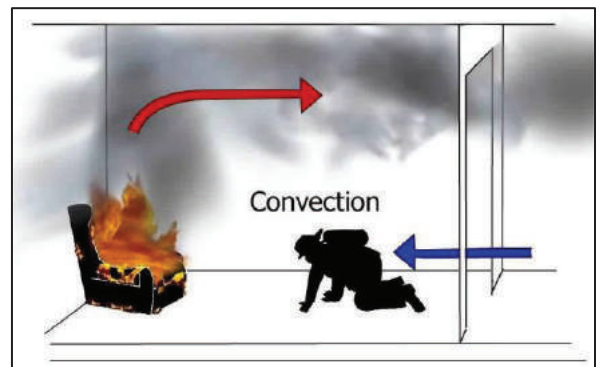

**Radiation** is the transmission of energy as an electromagnetic wave without an intervening medium. Heat waves (infrared rays) are similar to light waves in nature but they differ in length and energy. As an object is exposed to radiant heat waves, it will absorb or reflect the heat depending on its properties.

Radiated heat is one of the major sources of fire spread and its importance demands an immediate defensive attack at points where radiation exposure is severe.

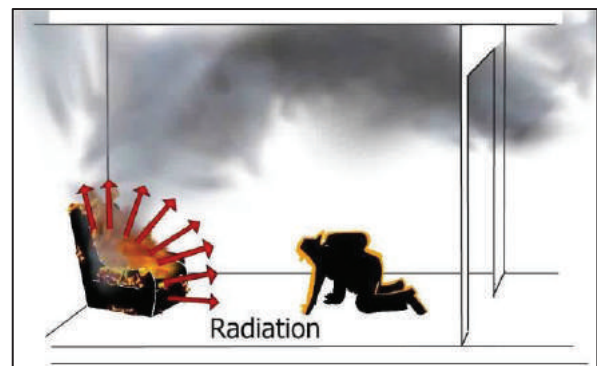

## Products of Combustion

When a fuel burns there are three products of combustion:

1. **Thermal Energy** is released as heat and flame.
2. **Smoke (Particulate)** is solid matter made up of unburned, partially, and completely burned substances.
3. **Toxic Smoke (fire gases)** is made up of the various gases produced during the combustion process. A few examples are carbon monoxide, hydrogen cyanide, and chlorine.

---

## CLASSIFICATION OF FIRES

Fires are classified into five categories of fire based on important properties, such as the materials combusting and the means of extinguishment. Identifying the correct class of fire is integral to any fire-fighting response.

**Class “A”** - Fires involve ordinary combustibles materials, such as paper, wood, and cloth. These fires require a cooling, blanketing, or wetting extinguishing agent such as water or multi-purpose dry chemical.



**Class “B”** – Fires involve flammable liquids such as gasoline, kerosene and greases. Extinguishing agents for this type of fire include carbon dioxide, dry chemical and foam that can interrupt the chemical chain reaction, exclude oxygen, and inhibit the release of combustible vapours.



**Class “C”** – Fires involve energized electrical equipment. A typical extinguishing agent is carbon dioxide. High value areas are protected with “clean agents” that leave no residue on electrical equipment. If the electricity can be de-energized (turned off), the underlying fuel is often class A or B.



**Class “D”** - Fires involve combustible metals such as magnesium, potassium, lithium, titanium, and aluminum. Special dry powder extinguishing agents are required for this class of fire, and must be designed for the specific hazardous metal. If not available, dry sand can be used. **Do not use water.**



**Class “K”** - Fires involve commercial kitchen appliances with vegetable oils, animal oils, or fats at high temperatures. A wet potassium acetate, low pH-based extinguishing agent is used for this class of fire.



---

## PHASES OF FIRE

When fire is confined to a building or room, a situation develops that requires carefully calculated and executed ventilation procedure to prevent further damage and reduce danger. This type of fire can be best understood by an investigation of its four progressive phases:

- Incipient
- Growth
- Fully Developed
- Decay

### Incipient (Ignition) Phase

The incipient phase starts when the elements of the fire tetrahedron come together and combustion begins. The oxygen content in the air has not been significantly reduced and the fire is producing some gases. The temperature in the room during this phase will only be slightly increased.



### Growth Phase

During the growth phase, oxygen-rich air is drawn into the flame as convection (the rise of heated gases) carries the heat to the uppermost regions of the confinement area. The heated gases spread out laterally from the top downward, forcing the cooler air to seek lower levels and eventually igniting all the combustible material in the upper levels of the room. This process is known as **thermal layering**. Additional fuel is ignited and the fire grows in size. **Flashover** can occur spontaneously and rapidly with a release of dangerous amounts of heat and into the next phase of the fire.



### Fully Developed Phase

During the fully developed phase, oxygen is consumed rapidly and the heat produced is at its maximum. All combustible materials in the compartment are burning and producing large volumes of fire gases. The fire will continue to burn as long as fuel and oxygen remain.

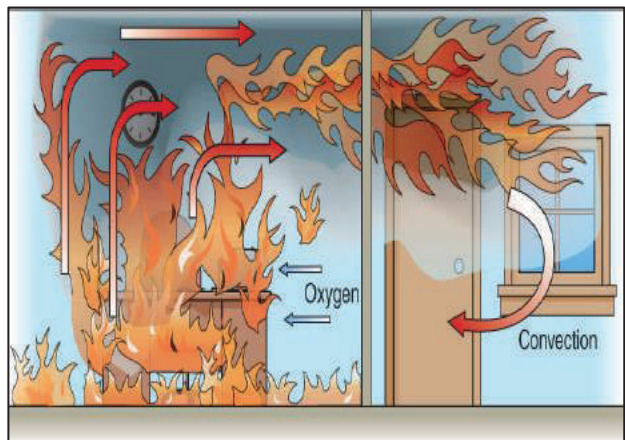

---

### Decay Phase

In the decay phase, flame may cease to exist and the fuel and/or oxygen are nearly exhausted. Burning is reduced to glowing embers. The fire will continue to smoulder and the room will completely fill with dense smoke and gases of combustion. Eventually the fire will go out.

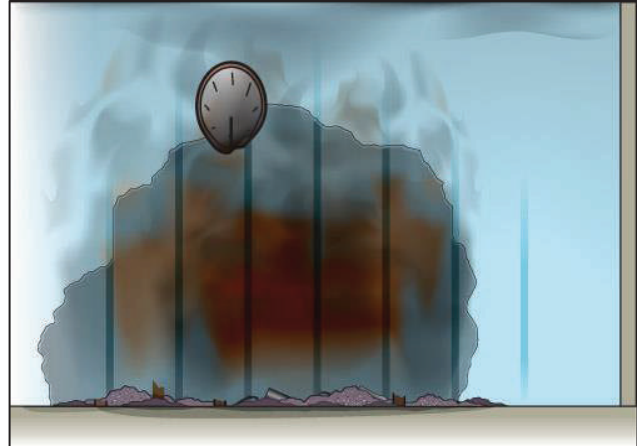

### HAZARDS OF FIRE DEVELOPMENT

**Rollover** occurs when unburned combustible gases that were released during the ignition or growth phase of a fire accumulate at the ceiling. When they mix with oxygen and reach their flammable range, they ignite and a fire front (licks of flame igniting in upper layers of smoke) develops, expanding very rapidly and rolling across the ceiling.



**Flashover** is the transition from the growth phase to the fully developed phase of a fire. It occurs when the surfaces and contents involved in the fire have been heated and gases given off by pyrolysis have ignited. Flame breaks out almost at once over the surface of the contents involved in the space.



Signs of flashover are:

- Dense black smoke
- Fire gases begin to fill the fire area
- Rollover is visible



---

**Backdraft** usually occurs during the decay phase when a fire is smoldering. If there is insufficient oxygen, the unburned gases may collect in pockets throughout the structure or fill the entire building. Such a condition needs only the admission of sufficient fresh air (oxygen) to cause a very rapid burning of these gases, the expansion of which may be sufficient to cause an explosion.

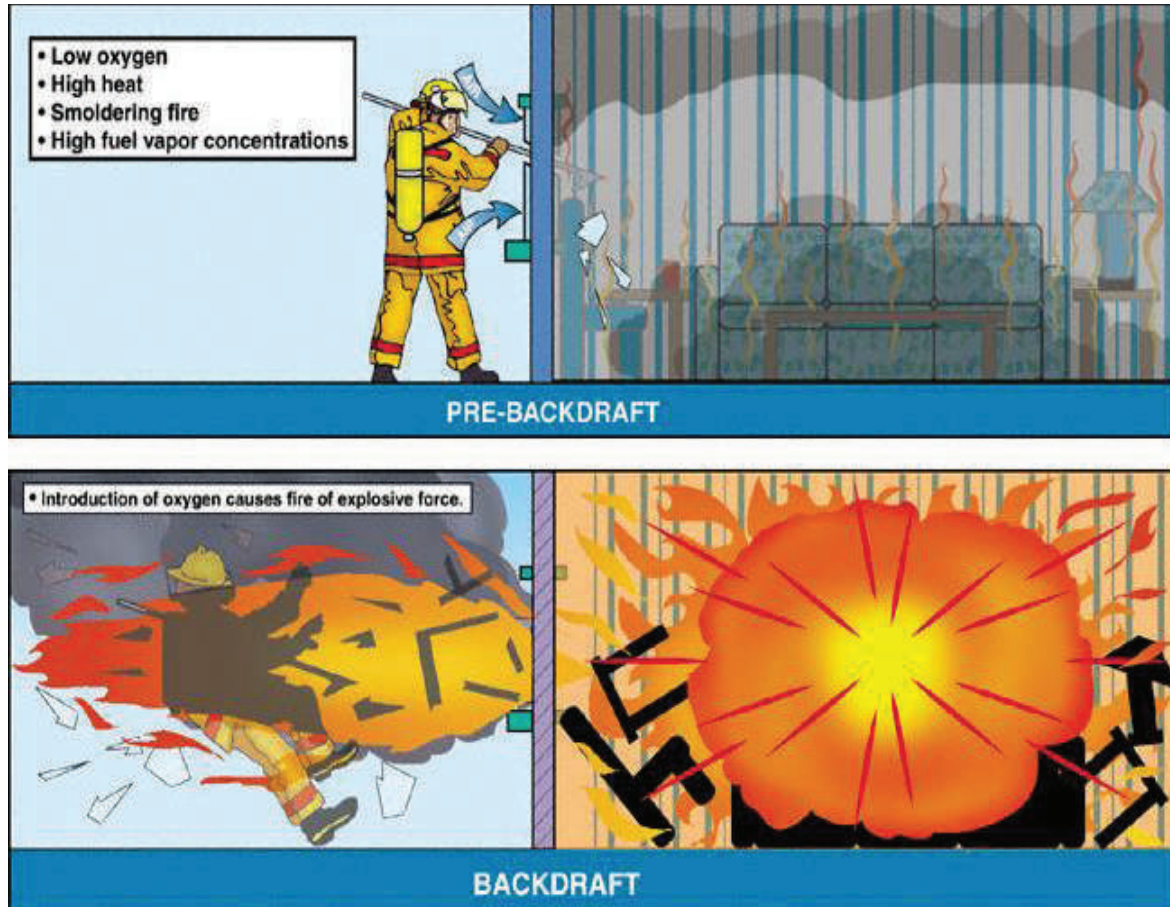

The degree of intensity of the back draft depends upon the degree of confinement, the amount of heated gases, and the rate and volume of fresh air (oxygen) admitted. This type of condition can be made less dangerous by proper ventilation.

Signs of impending backdraft:

- Little or no visible flame
- Smoke emanating under pressure from cracks, i.e., around windows or doors
- Smoke may be drawn back in
- Smoke is exiting in puffs or intervals
- Black smoke becoming dense grey yellow
- Smoke-stained or blackened windows



**Thermal Layering** is caused by convection and is the tendency for gases to form into layers according to their temperatures. It is also known as heat stratification or heat balance. The hottest gases tend to accumulate at upper levels, a phenomenon known as mushrooming. Cooler gases accumulate at lower levels. Thermal layering is disrupted when water is applied directly into the layer without proper ventilation. This results in steam, smoke, higher temperatures and decreased visibility at the lower level which are detrimental to a rescuer.

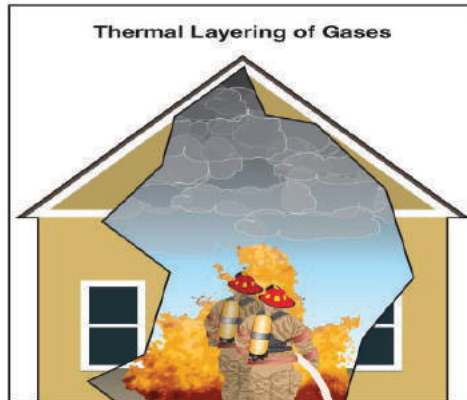

## FIRE EXTINGUISHERS

### Fire Extinguisher Classification

Fire extinguisher classification is based on physical fire extinguishing potential. Extinguishers are designated as Class "A", Class "B", Class "C", Class "D", and Class "K", with some types having a dual or triple classification.

The classification consists of a number and a letter. It appears on the label affixed to the appliance by the Underwriters' Laboratories of Canada (ULC) or another recognized agency.

The numeral indicates the approximate relative fire extinguishing potential of the extinguisher. In addition, it is an approximation of the number of square feet (1ft<sup>2</sup> = 0.09 m<sup>2</sup>) of appreciable depth flammable liquid that may be extinguished. Appreciable depth is defined as a depth of liquid greater than ¼ inch (6 mm).

The letter refers to the class of fire.

The number indicates "units" of fire extinguishing potential and does not refer to the size, capacity or quantity of extinguishing agent used. These ratings are based on an untrained operator. An expert can be expected to extinguish up to 2.5 times as much fire as a novice with the same quantity of agent.

**1A** = agent contained is equivalent to 1.25 U.S. gallons (4.7 L) of water

**B** = rated to extinguish the square footage of Class B fire

**C** = non-conductive agent

### Examples:

- **4A 60B C** = agent contained is equivalent to 5 U.S. gallons (18.8 L) of water, rated to extinguish 60 ft<sup>2</sup> (5.6 m<sup>2</sup>) of Class B fire. Agent is non-conductive.
- **10A 80B C** = agent contained is equivalent to 12.5 U.S. gallons (47 L) of water, rated to extinguish 80 ft<sup>2</sup> (7.4 m<sup>2</sup>) of a Class B fire. Agent is non-conductive.

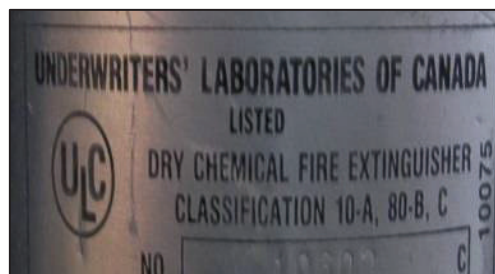
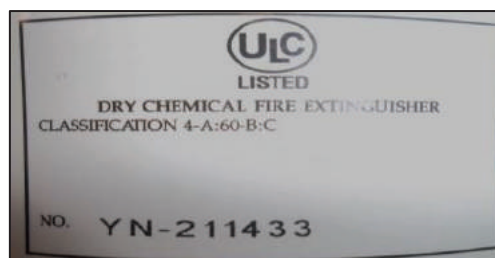

---

## Types of Fire Extinguishers

**Note:** Operating instructions must be clearly understood. Extinguishers must be fully charged, in their designated place, and ready for use.

### Hand-Operated Pump

Normally used for water-type agents only. It has a built-in hand-operated double-action pump that discharges water on a continuous up/down or in/out stroke. These extinguishers are normally rated Class "A" only.



### Stored pressure

The expellant and the extinguishing agent are stored within a single cylindrical container. The extinguisher will include:

- Pressure gauge
- Carrying handle
- Discharge lever with pin/tamper seal
- May or may not have a hose

This type of extinguisher can contain most agents including:

- Water
- AFFF
- Dry powder
- Dry chemical (including multipurpose)

These extinguishers may be rated for a combination of Class "A", "B" and/or "C" fires as well as Class "D". Check the label.



### Gas Cartridge

The expellant is contained in a separate cartridge. This cartridge is normally attached to the outside of the cylinder but it can also be found inside with the agent. This type of extinguisher primarily contains:

- Dry powder
- Dry chemical (including multipurpose)

These extinguishers can be rated for Class "A", "B", "C", "D" fires, or a combination thereof.



---

### **Self-Expellant**

In this type the expellant is the extinguishing agent. The agent has enough vapour pressure to expel themselves when the extinguisher is activated. These extinguishers can be rated for Class "A", "B", "C", "D" fires, or a combination thereof.



### **Large Wheeled and Stationary Units**

These units are located by fire protection specialists to cover specific risks in most cases, such as fuel and lube stations. These extinguishers can be rated for Class "A", "B", "C", "D" fires, or a combination thereof.



## Extinguishing Agents

Mine rescuers must be familiar with the different extinguishing agents available and the corresponding classes of fire.

Extinguishing Agent	Classes	Advantages	Limitations
Water	A	<ul style="list-style-type: none"> <li>• Non-toxic, plentiful, efficient</li> <li>• Converts from liquid to steam, absorbing heat in the process</li> <li>• Can be pressurized</li> <li>• Good range and penetration</li> <li>• Absorbs more heat per volume than any other agent</li> </ul>	<ul style="list-style-type: none"> <li>• Generally safe for only Class A fires</li> <li>• Electrically conductive</li> </ul>
Carbon Dioxide	B, C	<ul style="list-style-type: none"> <li>• Does not leave a residue</li> <li>• Non-freezing</li> </ul>	<ul style="list-style-type: none"> <li>• Limited range</li> <li>• Affected by the wind</li> <li>• Can be hazardous if used in a confined or unventilated space</li> <li>• Cold shock to electrical equipment</li> </ul>
Dry Chemical (standard ordinary base)	B, C	<ul style="list-style-type: none"> <li>• Non-freezing</li> <li>• Can be used with water stream or fog</li> <li>• Can be used in the wind</li> </ul>	<ul style="list-style-type: none"> <li>• Leaves a residue</li> <li>• Can be corrosive</li> <li>• Limited range</li> <li>• Limited cooling effect</li> </ul>
Multi-Purpose Dry Chemical	A, B, C	<ul style="list-style-type: none"> <li>• Non-freezing</li> </ul>	<ul style="list-style-type: none"> <li>• Leaves a residue</li> <li>• Limited range</li> <li>• Limited cooling effect</li> </ul>
Foam (Two classes: Class A and B)	A, B	<ul style="list-style-type: none"> <li>• Class A foam has excellent wetting and penetrating properties due to low surface tension</li> <li>• Class B foam can make water float on fuels that are lighter than water</li> <li>• Class A/B create a vapour seal on fuels</li> </ul>	<ul style="list-style-type: none"> <li>• Leaves a residue</li> <li>• Will freeze</li> <li>• Requires selection of correct foam for the fire application</li> </ul>
Dry Powder	D	<ul style="list-style-type: none"> <li>• Specific agents used for Class D fires</li> </ul>	<ul style="list-style-type: none"> <li>• Incorrect application can spread the fire</li> <li>• Not widely available</li> <li>• Specific to only one type of metal</li> </ul>
Wet Agents	K	<ul style="list-style-type: none"> <li>• Saponification turns oils and fats into soap/foam</li> <li>• Creates thick blanket to smother the fire</li> <li>• Effective, easy to clean up</li> </ul>	<ul style="list-style-type: none"> <li>• Only rated for Class K fires</li> </ul>

---

## Portable Fire Extinguishers

The basic components of portable fire extinguishers are:

- **Cylinder or Container:** Holds the extinguishing agent. Some extinguishers also contain expellant, which can be stored internally (stored pressure) or externally (cartridge type).
- **Handle:** Used to carry an extinguisher and to be held during use.
- **Nozzle/Horn:** Expels agent. Attached to the valve assembly or at the end of a hose.
- **Activation Mechanisms:** Discharges agent when activated.
- **Locking Mechanism/Tamper Seal/Pin:** Prevents accidental discharge.
- **Pressure Indicator:** On stored-pressure extinguishers, the gauge shows pressure of extinguishing agent stored. Some cartridge extinguishers have a pin that indicates whether it has been pressurized. Other extinguishers may not have any indicator.
- **Label:** Indicates classification, agent, as well as maintenance and use instructions.

## VENTILATION

**Ventilation** is an important firefighting tactic that involves the expulsion of heat, gases, and smoke from a fire building, permitting the mine rescuers to safely find trapped individuals and attack the fire. If not properly ventilated (e.g., poorly timed or located), a fire can:

- Be much harder to control
- Produce enough heat to create a flashover
- Result in conditions conducive to backdrafts
- Increase the fire's air supply, causing it to grow and spread rapidly.

### Natural

- Open doors/windows, wind, etc.
- Can be vertical or horizontal

### Mechanical

- Positive Pressure Ventilation (PPV) – PPV fans
- Negative Pressure Ventilation (NPV) – Smoke ejectors

### Hydraulic

Water fog spray – Nozzle at 60 degree fog pattern covering 90% of an opening

### Advantages of ventilation

- Aids life-saving and rescue
- Controls fire spread
- Reduces mushrooming
- Permits prompt salvage operations by reducing smoke, heat, water, and fire damage
- Speeds attack and extinguishment
- Reduces danger of backdraft
- Reduces hazard to rescuers

### Considerations for Safely Performing Ventilation

- Location, duration, and extent of fire
- The age and type of structure involved
- Escape routes for rescuers and casualties
- Need, type, and location of ventilation
- Whether ventilation can be performed safely
- Trained personnel, tools, and equipment available

---

## EQUIPMENT FIRES

Mine rescuers should not attempt to fight equipment fires unless they can do so competently and have the necessary equipment. Mine rescuers must be aware of the numerous hazards present in equipment fires. These include but are not limited to:

- Fuel and lubricant volumes
- Batteries and electrical
- Stored energies, e.g., hydraulic components, airbags, and tires
- Unidentified cargo



## BLEVE (BOILING LIQUID EXPANDING VAPOUR EXPLOSION)

**The information contained within this section in no way prepares the rescuer to actively respond to potential BLEVEs. Always operate within your scope.**

A confined gas or liquid is potentially dangerous, regardless of whether the content is flammable. BLEVEs can be caused by a fire near or impinging the storage vessel, heating the contents and increasing the pressure inside.

Storage vessels are designed to withstand the stored pressure, but impinging flame can cause the metal to weaken and eventually fail. If the storage vessel is being heated in an area where there is no liquid, it may rupture faster without the liquid to absorb the heat.



Pressurized vessels are equipped with relief valves that vent off excess pressure, but the vessel can still fail if the pressure is not released quickly enough. Relief valves are sized to release pressure fast enough to prevent the pressure from increasing beyond the strength of the vessel, but not so fast as to be the cause of an explosion. An appropriately sized relief valve will allow the liquid inside to boil slowly, maintaining a constant pressure in the vessel until all the liquid has boiled and the vessel empties. If the substance being stored is flammable, once the vessel fails the liquid immediately turns into a rapidly expanding cloud of vapour that ignites into a huge fireball. Mine rescuers must keep in mind that a BLEVE can send solid projectiles flying for great distances.



---

## Western Canada Mine Rescue Manual

# Chapter 11 Rope Rescue





---

## OBJECTIVES

The primary objective of mine rescue work is the safe recovery of casualties, often from dangerous and inaccessible places. This will frequently require the use of ropes and harnesses to allow mine rescue workers to reach the injured and to raise or lower them to safety. Upon completion of this chapter, the trainee shall be able to demonstrate competency in:

- Rope rescue personal protection equipment
- Key concepts and definitions
- Ropes, webbing, hardware, and related equipment, and their uses in rescue work
- How to tie a number of knots, bends and hitches used in rescue work
- How to prepare rescue harnesses and secure a patient to a rescue stretcher
- How to set up a safe anchor system
- How to build mechanical advantages
- How to build safety belays and the radium release hitch

### Introduction



The basic goal of any rescue recovery operation is to remove the casualty from his or her predicament as quickly as possible with maximum safety provided to both the rescue team and the casualty.

Rope rescue is a dangerous activity. Safety must be stressed at all times, such as when selecting equipment, techniques, and personnel.

**Technical rescue is a hazardous activity. Risk management is a result of experience, training, and good personal judgement. The skills and techniques shown in this chapter are for expert use only. It is your responsibility to seek competent, hands-on instruction as well as to obtain quality equipment and to follow safety procedures.**

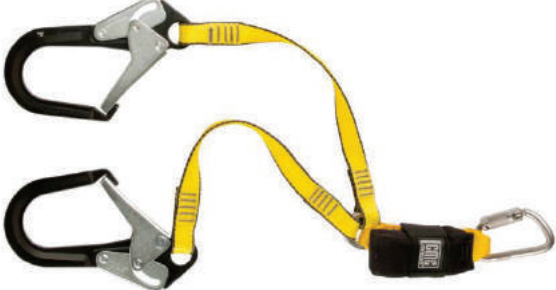

**PERSONAL PROTECTION EQUIPMENT**

Equipment	Photo
<p><b>Gloves:</b> All rescuers handling a moving rope must wear protective gloves. These will provide protection from rope burns and to some degree from pinch points. They should be snug for dexterity and increased gripping ability. Only use gloves made of leather or with thick synthetic palms to resist abrasion.</p>	
<p><b>Pliers:</b> Used to free a jammed carabiner.</p>	
<p><b>Knife or Suitable Cutting Tool:</b> Used to cut open jammed systems. Must be kept sharp.</p>	
<p><b>Rescue Harnesses:</b> Must be commercially manufactured, NFPA certified Class III. The harness style needs to have the capability of providing two separate frontal tie-in points, one at the chest level for belay attachment and one at the waist level for front load-bearing attachment. A third dorsal D attachment point for fall arrest is also required.</p>	
<p><b>Lanyard:</b> Used as an attachment between the rescue harness and secure anchor point. Must meet minimum relevant health and safety legislation of jurisdiction.</p>	

**All safety precautions must be in place before freeing a jammed system by cutting.**

---

## ROPE AND WEBBING

### Rope Design and Construction

Rope is used for rescue or recovery work and climbing. Being able to use rope properly is important in both underground and surface mine rescue. Bringing an injured patient out of a stope is no different from raising an accident casualty up over a bench in an open pit mine or over a natural obstacle on the surface.

### Synthetic Rope

Synthetic ropes have replaced natural ropes for mine rescue work. Synthetics are resistant to mildew and rot, and stronger for equivalent diameters. They are resistant to abrasions and easy to handle.

### Kernmantle

Kernmantle rope is rope that is not twisted. Instead, the “kern” or interior core is made of units of nylon fibers. The mantle is then woven around the outside of the nylon fibers.

Most rope rescue operations use nylon kernmantle ropes. The nylon core supports as much as 90% of the load’s mass, while the mantle protects the rope. Some kernmantle ropes have a coating on top of the mantle that is designed to protect the rope from water, cuts, and other damage. However, the coatings make ropes slippery and therefore unsuitable for rope rescue.

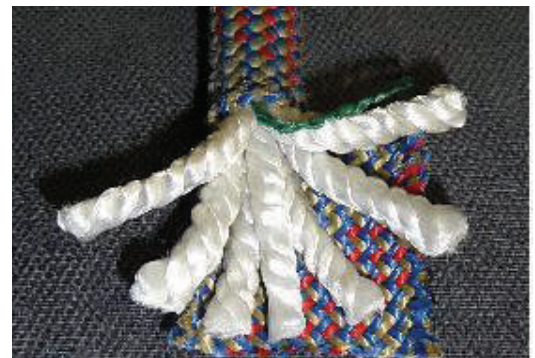

*Kernmantle rope*

### Low-Stretch Ropes (Static Kernmantle - Rescue):

- Strongest of the common rope types
- Thicker sheath, more abrasion resistant
- Tend to be stiffer than climbing ropes
- Stretches approximately 3–5% with a one-person load or 2% with a 200-lb. load

### High-Stretch Ropes (Dynamic Kernmantle - Climbing):

- Not suitable for rescue operations except where single-person climbing is required
- The mantle is thinner than static ropes, susceptible to abrasion and dirt
- Stretches approximately 5–9% with a 200-lb. load
- Designed for single person load
- The high stretch absorbs shock in cases such as a falling lead climber (climbing above anchor points). Lead climbing is beyond the scope of this training manual and program. Site specific training must be provided to rescue personnel who may be required to climb.

### Rope Attributes

**Tensile Strength** is the ability to withstand force that is applied slowly to the point of failure, e.g., with a weight suspended from a rope.

**Breaking Strength** is the amount of force required to break the rope with a straight pull, such as in a tug-of-war where the amount of pull gradually increases.

---

**Safe Working Load**, or load capacity, is the weight or force that can safely be applied to a rope. The maximum safe working load is a percentage of the breaking strength.

**Safety Factor** is the ratio of the rope's breaking strength to its maximum safe working load. The safety factor is meant to account for wear and tear and reduction of integrity under operating conditions.

**Do not consider the safety factor of a rope as reserve strength to be used for additional capacity.**

### Safe Working Load

The **safe working load** (SWL) for rope uses a factor of ten as a safety margin. It can be calculated by using this formula:

$$SWL = MBS \div 10$$

where SWL is the Safe Working Load and MBS is the minimum breaking strength

Consult your specific rope manufacturer for breaking strength. At a minimum, ropes used in rescue work should meet the guideline in NFPA 1983 for "General Use". The ropes must also maintain a 10:1 safety factor.

**Force:** Something that causes or restrains motion. The formula for calculating force is:

$$F = M(A)$$

where F is Force, M is Mass, and A is Acceleration.

A **Newton (N)** is the measurement used to represent the amount of force needed to move one kilogram of mass at the rate of one meter per second squared (1N = 1 kg m/s<sup>2</sup>). The most commonly used unit of measurement for the forces encountered in rope rescue is the kilonewton (kN, 1 kN = 1,000 N).

Classification	Rope Diameter	Rated Load (Persons)	Rated Load (Weight)	Minimum Breaking Strength
Personal Escape Rope	19/64" (7.5 mm)–3/8" (9.5 mm)	One	300 lb (136 kg)	3,034 lbf (13.5 kN)
Light-use Life Safety Rope	3/8" (9.5 mm)–1/2" (12.7 mm)	One	300 lb (136 kg)	4,496 lbf (20 kN)
General-use Life Safety Rope	1/2" (12.7 mm)–5/8" (16 mm)	Two	600 lb (272 kg)	8,892 lbf (40 kN)

Source: NFPA 1983, *Standard on Life Safety Rope and Equipment for Emergency Services*

**Always check the manufacturer's specifications to determine the strength of the rope being used.**

---

## Caring for Rescue Ropes

### Inspection

- Inspect new ropes prior to service and after every use
- Examine for damage:
  - History of impact by an object
  - Melting
  - Flattened or soft spots that cannot be worked back into shape
  - Bulges and other irregularities
  - Cuts or core showing through the outer sheath
  - Extreme sheath slippage
  - Discolouration or any other signs of exposure to contamination

### Usage

- Avoid stepping on ropes.
- Protect from falling objects such as rocks.
- Avoid dirt or grit that may work into the core and cause damage not immediately visible.
- Do not let moving ropes cross against stationary ropes or webbing as friction can cause melting.
- Use edge protection to prevent abrasions.
- Avoid twisting or kinking.
- Use pulley blocks that are four times the width of the rope being used.
- Do not smoke around ropes and rigging equipment during rescue operations.

### Storage

- Protect from exposure to chemicals, high temperatures, and direct sunlight
- Dry, coil, or bag properly after each use
- Maintain an inventory and rope service log for each rope in use

### Cleaning

- Wash ropes with a rope washer or by hand with a brush
- Ropes can also be cleaned in a washing machine but only if they are properly chained and the washing product is suitable.

### Retirement

- Retire rope if it does not pass inspection or after it has been in service for five years.
- Retire rope if experiencing high sheath abrasion, i.e., if more than 50% of the rope appears worn, or 30% of the fibres of the webbing are worn.
- Once retired, cut rope into small pieces so that they cannot be used.

### Cordage

There are two basic classes of cordage, each with their own special uses: **Prusik** and **Accessory Cord**.

**Prusik Rope** is designed to be flexible enough to grip rope. A rescuer should be able to squeeze cordage together between two fingers.

- Used for self-rescue, rope grabs, belaying, and release hitches.
- Prusik rope is 8–9 mm in diameter when used for rope rescue systems and must be a minimum of 2 mm smaller than the rope it is being tied to.

---

**Accessory Cord** is any narrow diameter rope made from nylon, polyester, Spectra, Kevlar or combination thereof.

- Not pliable enough to be used for prusiks.
- Accessory cord used for radium load release hitches and other applications in technical rope rescue is 100% nylon with a diameter of 8–9 mm.

### Webbing

Webbing is primarily used for harnesses and slings. It can be best described as flat rope. **Flat Webbing** is constructed of a single layer of materials, just like seat belt webbing. **Tubular Webbing** is used in high-angle environments because it is more flexible. You can recognize tubular webbing because it is hollow and forms a tube when two ends are squeezed inward. Tubular webbing is:

- Sometimes preferable to rope
- Constructed of nylon or polyester
- More comfortable than rope against the body for harnesses
- Has a wide, flat surface so it can be more abrasion resistant in many rigging applications



L-R: Tubular, Flat

## HARDWARE

Rescue teams use a number of pieces of hardware in their operations, including carabiners, brake bars, descending equipment, pulleys, steel O rings, anchor plates, tri-links, stretchers, and more. Proper use and care of the core pieces of hardware is described below.

**Carabiners** are metal connectors that link the elements of a rescue system. The basic parts of a carabiner include the spine, hinge, lock, gate, and latch. Carabiners used in rope rescue:

- Must be inspected before and after every use
- Must be tested as per manufacturer's specifications

### Basic Carabiner Shapes

Carabiners are manufactured in a variety of shapes. Each shape is designed for specific uses. The strongest design is the D-shaped carabiner. The D-shaped spine is longer than the gate side, and the top and bottom of the carabiner flare toward the spine. This design causes ropes attached to the carabiner to slip into position along the spine, where the carabiner is strongest.

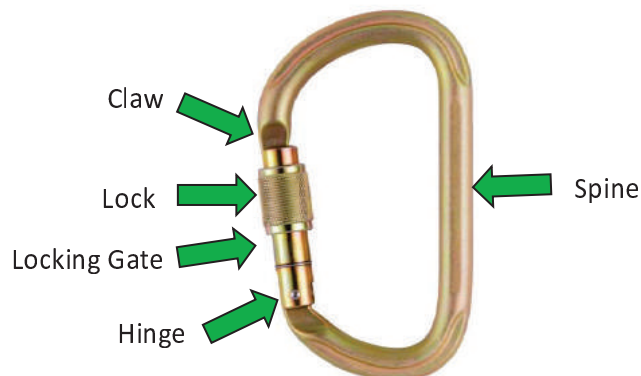

**Warning: Locking carabiners can come open after being locked.**

### Additional Concerns for Locking Carabiners

If a carabiner frequently unlocks without an apparent cause, then it should be retired from service. Carabiners are designed to be locked only to light-finger tightness. In their concern for safety in high-angle environments, some people will over-tighten a locking carabiner and then be unable to unlock it. This situation commonly occurs when a person tightens down hard on the seat harness carabiner while someone is hanging in the harness.

If a carabiner locking mechanism becomes “frozen” through over-tightening, the following procedure typically releases it:

1. If the carabiner is not already on a seat harness, attach it to one. Have the wearer move to a secure position, such as away from the edge of any drop.
2. Attach the carabiner via a sling to a convenient anchor mode.
3. Reload the carabiner by sitting down with it attached to the anchor point.
4. In many cases, the locking nut can then be easily loosened.
5. If it still cannot be loosened, try tightly wrapping a short piece of webbing around the lock nut to gain leverage.
6. If this does not work, using pliers may be the only remaining option.

### Care and Maintenance

- Do not drop or strike against other objects
- Avoid chemical and particulate contamination
- To prevent accumulation of grit, do not apply oil excessively

**All rescue equipment must be maintained and used in accordance with manufacturer’s recommendations.**

### Using Carabiners Properly

A carabiner is strongest when loaded along its spine. Improper loading transfers the load to weaker areas of the carabiner. This will dramatically reduce the strength of the attachment.



#### Tri-Links

Tri-links are designed to be loaded in three directions. They are very useful for anchoring or rigging situations in which a carabiner would not be suitable due to undesirable side loading.

### Pulleys

Pulleys are used to change the direction of a pull on a rope. Some pulleys are rated for single-person rescue only. The NFPA General Use minimum breaking strength is 36 kN (8,093 lbf). For rope rescue, use the 4:1 pulley-to-rope ratio, meaning that the pulley size (also known as the “tread diameter”) is four times the diameter of the rope.

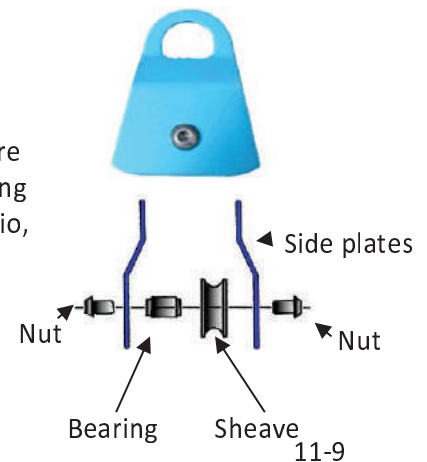

---

## Types of Pulleys

**Single and double sheave pulleys** are used primarily for building mechanical advantage systems. Most double sheave pulleys come with a becket. The becket is an anchor point for attaching a carabiner to secure the end of the rope.

**Prusik Minding Pulleys (PMPs)** are designed to prevent the prusik from passing through the pulley.

**Swivel pulleys with side plates** have side plates that can be opened while under load, making them more versatile than regular pulleys. They come in single and double sheave.

**Knot Passing Pulleys** have a large throat that enables knots or bends (that attach two ropes together) to pass through the pulley. This pulley can also be used for directional changes or edge protection.



L-R: Single Pulley, Prusik Minding Pulley, Swivel Pulley, Knot-Passing Pulley

## Descent Devices

If given a choice for rope rescue operations, lowering systems are preferred because:

- They are simpler
- They require less rigging
- They use gravity as an advantage
- They require fewer personnel to operate

**Other commercially made devices are approved for rescue systems. Operating this equipment requires specific training. If using these devices, follow all manufacturer's instructions.**

**Brake bar racks** consist of a number of brake bars attached to a rack designed for the purpose of braking. The amount of friction applied to the rope can be adjusted by adding or removing bars and increasing the space between the bars. Brake bar racks:

- Have a minimum breaking strength of 10,000 lbs (4,536 kg)
- Should be tested annually
- Are tied off with two wraps around the rack and two half hitches around the main load line
- Are variable friction devices, some have a thicker second bar or hyper bar, which improve control and help dissipate heat
- Use in-line operation, can control two ropes simultaneously. Can have up to six bars and worn out bars can be replaced.
- Should be operated as per manufacturer's recommendations. To avoid falling, make certain to **pre-tension** the brake rack. Rescuers pre-tension brake racks every time the bar is used. To pre-tension the brake rack:
  1. Establish a plumb point. Hold the load-side knot tight about two inches past the access



Threaded Brake Bar Rack

- edge and then around the first bar of the brake rack.
2. Tie off the rescuer holding the load side while making sure the load-side rescuer maintains the plumb point.
3. The other rescuer then weaves the rope through the remaining bars and locks the brake rack.
4. Attach the safety belay to the load, followed by the main line. Slowly work the belay system until it is loaded.

**Steel O-Rings** are used for rigging anchor systems, and are also used as a Master Point of Attachment.

- They are very strong, with a strength margin of at least 20:1.
- They can safely accommodate a main line, safety belay line, and rigging harness.
- They have an inside diameter of three inches.



*Steel O-Ring*

**Anchor Plates** for anchor systems make an excellent collection point and allow rescuers to set up their systems quickly and cleanly.





**Edge/anchor protection** prevents damage to the rope and is commonly used when attaching rigging to anchors. There are commercial products available or they can be improvised on-site. Every effort should be made to prevent damage to the rope.

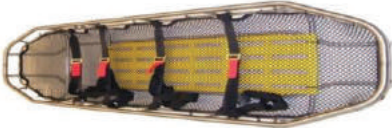

*Anchor Plates*

### Rescue Stretchers

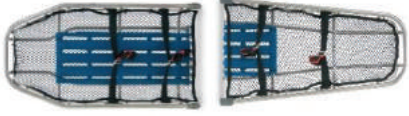
A variety of stretchers are available, but only ones designed for rope rescue should be used. Carry and evacuation stretchers are not designed to handle the same stresses. Most stretchers are either plastic or metal, and some come equipped with head protection and attachment points for carabiners. Read all manufacturer's instructions and specifications when determining which stretchers to use. Stretchers should be inspected before and after every use.

 <p><b>Metal:</b> has a metal tubing frame. Some are lined with wire or plastic. This type is very rugged.</p>	 <p><b>Plastic:</b> made of high-density polyethylene shell with a metal frame. Works well on dirt, grass and snow surfaces.</p>	<p><b>Flexible plastic:</b> Portable, light, fits through small openings.</p> 
 <p><b>Two piece:</b> easier to carry to remote locations.</p>	 <p><b>Fiberglass/Composite:</b> durable, light weight, not affected by extreme cold.</p>	



---

## KNOTS, BENDS, AND HITCHES

Knots are essential components of all rope rescue operations. The knot you use depends on the situation and environment of the rescue. Rescuers must be able to tie the following knots, bends, and hitches in all conditions. When deciding on a knot, consider the following factors:

- The knot must have been proven to be safe for its intended use.
- The knot must be strong enough for its role in the operation.
- It must be easy to tie and untie.

All knots reduce the strength of the rope. The knot must not affect the strength of the system beyond the acceptable safety factor.

For animations of the following knots, bends, and hitches, please visit <http://www.animatedknots.com>.

### Terminology

**Knot:** A connection method used in rope or as in webbing to tie it to itself.

**Bend:** A tie that connects the ends of two ropes or webbing together.

**Hitch:** A tie that attaches a rope or webbing to another object such that if the object were removed the tie would fall apart.

**Bight:** A bight is an open turn formed when a rope is doubled back upon itself making a turn but not crossing over itself.



**Standing Part:** The inactive section of rope during the process of tying a knot.

**Running End:** The end of rope that threads through to complete the knot.





**Loop:** A turn of rope that crosses itself.

**Tail:** The free end of rope that extends from a knot.





**Safety Knots:** Used to prevent fraying and to stop from sliding through a block, hole, or other knot.

Name	Notes	Diagram
Overhand Knot	Basic safety knot	
Figure Eight	Basic safety knot	





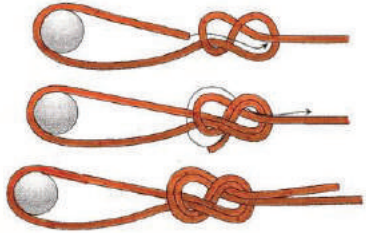

## Knots

Name	Notes	Diagram
Bowline	A loop that will not jam, slip, or fail	 A blue rope is tied into a bowline knot, forming a single loop with a fixed end.
Bowline on the Bight	Creates a double loop	 A blue rope is tied into a bowline on the bight, creating two loops of equal size.
Figure of Eight on a Bight	Creates a loop that forms the main point of attachment	 A blue rope is tied into a figure of eight on a bight, forming a single loop with a fixed end.
Double Figure of Eight	Creates two loops that form the main point of attachment	 A blue rope is tied into a double figure of eight, creating two loops of equal size.
Butterfly Knot	Creates a loop in the standing part of the rope that provides an attachment point for multi-directional use	 A blue rope is tied into a butterfly knot, creating a loop in the standing part of the rope.

## Bends

Name	Notes	Diagram
Double Sheetbend	Used for tying two ropes of unequal size together	
Double Fisherman's	Used to join two ropes of equal diameter	
Ring Bend	For connecting webbing to webbing	
Figure of Eight Bend	Used to tie two rope ends together end-to-end, in order to extend them.	
Figure of Eight Follow-Through	Used to anchor a rope around an object without the need of other equipment.	

## Hitches

Name	Notes	Diagram
Clove Hitch	Used for securing a rope to a pole or post. It is often used as a starting point in lashing.	 <p>A blue rope is wrapped twice around a horizontal wooden pole. The two ends of the rope are then crossed and secured together to form a clove hitch.</p>
Timber Hitch	Used to hoist or drag timber or pipes	 <p>A blue rope is wrapped twice around a vertical wooden post. The rope is then twisted and secured to form a timber hitch.</p>
Munter Hitch	Used for single-person belaying in low-angle situations	 <p>A green rope is attached to a silver metal carabiner. The rope is wrapped around the carabiner and itself to form a Munter hitch.</p>
Prusik	Friction hitch used to attach a larger diameter rope without knotting the rope. For hauling and brakes, use a three-wrap prusik.	 <p>A blue rope is wrapped three times around a red rope to form a Prusik hitch.</p>
Tensionless Hitch	Used for anchoring a rope	 <p>A blue rope is attached to a silver metal carabiner. The rope is wrapped around the carabiner and itself to form a tensionless hitch.</p>
Two Round Turns with Two Half Hitches	Used to secure rope to a post or pipe. Will take heavy strain without slipping or jamming.	 <p>A blue rope is wrapped twice around a vertical wooden post. The rope is then secured with two half hitches.</p>
Cat's Paw	Used to secure rope to hooks and rings	 <p>Two blue ropes are secured to a silver metal hook using the Cat's Paw hitch.</p>



---

## HARNESSES

Harnesses are designed to protect and hold the user's body. The type of harness used depends on the task to be carried out. In rope rescue, they are most commonly used to raise or lower a casualty.

### Butterfly Harness (Fig. 11-43)

The butterfly harness is used when only a rope is available to safely lower or raise a casualty from one height to another. It is not to be used as a working or rescue harness. Any impairment to the circulation to parts of the casualty's body can have serious consequences. The rope diameter should be 11mm or greater. Rescuers must also ensure that the duration of suspension is kept as brief as possible.

<p><b>1.</b> Measure four double arm lengths (approx. 20 feet, 6 m) of rope across the body to provide enough working line and tie an ordinary slip knot to form the first loop for one of the casualty's legs.</p>	
<p><b>2.</b> Place the loop around the casualty's right thigh, well up into the crotch. The rescuer's left hand holds the eye of the slip knot in the center of the casualty's body just below the chest.</p>	



3. Wrap a second loop around the casualty's left thigh, well up into the crotch and form a third loop. Push the third loop through the eye that is held secure by the rescuer's left hand.



4. Place the third loop under the casualty's left arm and over the right shoulder, then thread back through the eye. Make sure the rope enters through the eye as shown.



5. Continue the line and lay it across the left side of the casualty's neck. Continue along the casualty's back and under the right arm and bring it back through the eye on the chest forming the fourth loop at the eye.

**Note:** There will now be an X pattern from the rope on the casualty's back.



**6.** Tighten the eye snugly on all four loops by pulling on the hauling line which closes the eye. Adjust the harness for both tightness and comfort. Secure the eye to the loops with two half hitches to prevent slipping and tightening of the knot on the casualty's body.

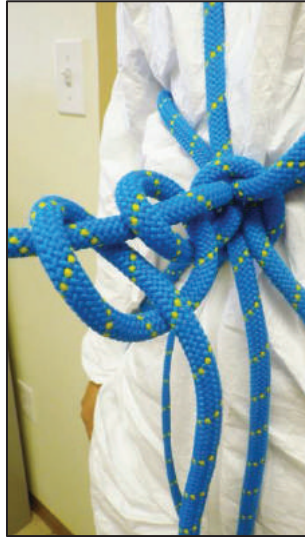

**7.** Tighten the half hitches to complete the harness. A safety knot can be tied in the harness rope tail or the tail can be connected to a separate rope line.

If possible, place padding between the rope and the casualty's body where there are points of pressure.







---



### Webbing Harness (Upright)

Made from webbing, this harness is for an upright person who requires an easy, quickly made full-body harness. It is to be used for short periods of time only, especially if suspended. There are many variations of this method, including a commercially made ready-to-use type.

Start by building the seat portion, and then build the chest portion. Finish by connecting the two together. Avoid placing the knot at locations that will cause pressure points on the wearer's body.

#### Seat Harness

	
<p><b>1.</b> Use a 15 foot length of webbing tied together in a loop with a ring bend. If the fit of the harness is too large, it can be adjusted at the ring bend by lengthening the tails.</p>	<p><b>2.</b> Hold the webbing at the waist line, hang a bend behind and in between the legs of the wearer. Pull the hanging bend through the legs to the front to meet the two made at waist level.</p>

	
<p><b>VERSION A: 3.</b> Connect all the bends together with a carabiner.</p>	





**VERSION B (Fits smaller people better): 3.** Grab the hanging bend that came from beneath the legs, separate, and pass it under each bend created at the waist. Pull these outwards to adjust fit, bring them together in front of the casualty, and attach them with a carabiner.

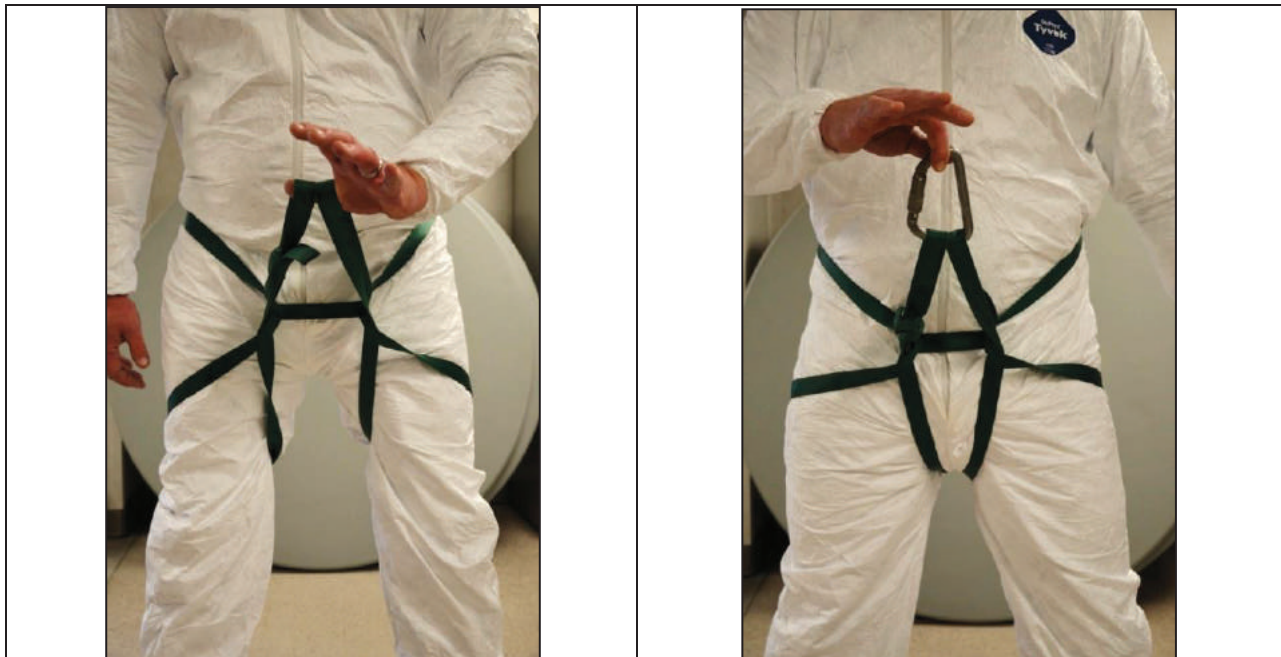

**4.** Have the wearer hold the carabiner while checking the fit and then begin building the chest portion. In some cases it is easier to build the chest portion first and let the carabiner hang. When the web seat is ready attach the two portions together to form the full body harness.

---

## Chest Harness



**1.** Use a 12-foot length of webbing connected in a loop with a ring bend. If the harness is too large for the wearer, it can be adjusted at the ring bend by lengthening the tails. Avoid placing the knot in such a way that it creates pressure points on the wearer's body.

**2.** Twist and hold the webbing so that there is a loop for each arm. Check that there is a crossover of the web on the person's back. Modifications may be required if physical injuries are aggravated by the webbing.



**3.** Pull the two arm loops to the front of wearer to snug and adjust the length if required.

---

Connect the seat and chest harness together with the carabiner to form the full body harness. Complete the following checks:

- Have the wearer lean back slightly while holding the carabiner. The weight should be on the seat portion and it should be comfortable.
- The harness should be snug so that it will not slip off during movement.
- Tie safety knots on any hanging ring bend tails that could interfere with rigging.
- The carabiner must not be side loaded and gate lock must be checked before and after attaching rope rigging systems.

**4.** If there is a long distance between the seat and chest connection points that prevents the use of a single carabiner to attach together, the following methods can be used as long as both harnesses are securely attached to each other:

- Add another carabiner and connect one to the seat and other to the chest harness. To complete connect the carabiners directly to each other.
- Add another carabiner. Use a short webbing or prusik cord to connect between chest and seat harness carabiners.



## Webbing Harness

This harness is used for casualties who are either unconscious or supine and require a rapid rescue.



**1.** Use a 24-foot (7.3 m) webbing tied together with a ring bend to form a large loop. Encircle the casualty that requires rescue.



**2.** Lift legs and pull the webbing up through the thighs.



**3.** Grab a portion of web lying on the floor by casualty through the loop end from the legs.

*Option:*

Pull the two new bends to snug the webbing around the wearer or connect them together with a carabiner. Rescuers can now drag or pull the casualty to be rescued like a sled.



**4.** Take the web portion that lays across the chest area. Pull and place it behind the casualty's neck.





**5.** Pull on the webbing to snug the harness to the wearer. The casualty can now be dragged or pulled from a hazardous location to a safer area by the rescuers.



**6.** If the web was placed behind the neck, the rescuers can also lift the casualty off the floor or obstacles by putting webbing straps over their own shoulders. The rescuers can now move together to a safe area in an almost full standing position.

For a rapidly applied harness, the webbing and the part behind the head causes minimal discomfort.

## Blanketing a Stretcher

There are various methods to blanketing a stretcher but the objectives are the same:

- Provide the casualty with warmth for shock or environmental conditions.
- Comfort the casualty by ensuring there is nothing that can cause pressure points on the casualty's body.
- Allow a rescuer to quickly access the vital signs and injuries of the casualty.
- Keep the blankets from being loose and potentially getting into rigging systems.

		
<p><b>1.</b> Lay blankets as shown. Avoid any bumps that could cause a pressure point</p>	<p><b>2.</b> Load casualty in, leave a space at least 4" from head to the rail if possible</p>	<p><b>3.</b> Wrap around legs. Keep loose at feet if a rope tie-in is to be used.</p>
		
<p><b>4.</b> Finish by pulling the upper body blanket over and tucking it in.</p>		

---

## **Basket Stretcher Tie-In**

Basket stretcher tie-in procedures are used to ensure the casualty:

- is secured sufficiently to reduce aggravation of injuries for during transport
- does not slide around or slip out of basket when transporting over uneven ground
- well secured while moving from one height to another
- does not move within the basket when it needs to be moved from partial tipping to a full vertical position
- is fully secured in the basket when the rescuer cannot accompany them for the duration of a rescue

There are many tie-in methods due to the variation of styles and design of rescue basket stretchers. One method may work perfectly on one basket and not well on another. Tie-in procedure may need to be modified due to factors such as:

- basket width and length
- location and number of support rails and cross members
- plastic versions that require a method that does not put pressure directly on the plastic portion which can cause ripping
- size and shape of the casualty
- orientation of casualty in the basket such as on their side (lateral)
- type and location of the injury and access to casualty's body parts
- the speed at which the casualty requires to be moved for safety reasons (danger)
- webbing/rope for tie in is too short or too long

Commercial tie-in kits are available, ranging from seat belt style to webbing kits designed specifically for certain baskets.

Blanketing is required to protect for the casualty from tie in contact points to the body. Padding underneath the casualty is required when long travel times are encountered. Rolled blankets can be used to make up spaces to reduce movement between the feet and the stretcher, casualty's head and stretcher, or at their sides. Using padding reduces sliding, provides comfort and can protect injuries. The casualty's arms should be placed under the blanket and at their sides whenever possible to make the tie-in process easier.

Items such as oxygen therapy units must be secured in the basket if there is a possibility of them falling out.

Care must be taken to protect the casualty's face from being whipped by the tie-in material.

The tie-in must be tight enough to provide the tension needed but not so much that it will cause patient discomfort. If conscious, ask casualty as the tie progresses for any concerns.

---

## Herringbone Tie-In

The herringbone tie-in can be accomplished with either webbing or a rope (use a large diameter such as 11mm to avoid discomfort to the casualty). The common length of a dedicated tie-in web or rope is at least 60 feet (18 meters). If done correctly the herringbone can be easily “unzipped” after undoing the last securing knots, which can be useful if a casualty needs to be removed from basket quickly and transferred to an ambulance cot.



**1.** Using a dedicated tie in length, thread half of it through the bottom section of the stretcher, below the lowest cross member. Half the tie will be each side of the stretcher.

**2.** If using a rope, lay the center of the tie in on top of the stretcher rail (1<sup>st</sup> loop), wrap around the feet with a clove hitch, pull the loop between the feet over the clove hitch. This can also be accomplished by wrapping the casualty's feet, making a clove hitch then pulling some slack to make the first loop that is then placed from the feet bottom over and between the feet. Twist the loop if it is too long.



**3.** If using webbing, form bights on each side of stretcher. Pull one through the stretcher and push through the 1<sup>st</sup> loop at the feet. Repeat with the other side to make a third. Keep tension as the tie in progresses. If there are double rails on the stretcher, it is preferred to thread under the bottom one as this pulls downward for a tighter fit.





**4.** Work up the stretcher repeating Step 3 using each cross member in turn. Maintain tightness as it progresses. Avoid placing bight ends over knees, groin, diaphragm (just under rib line) and any injuries. The last bight loop must be well away from throat.

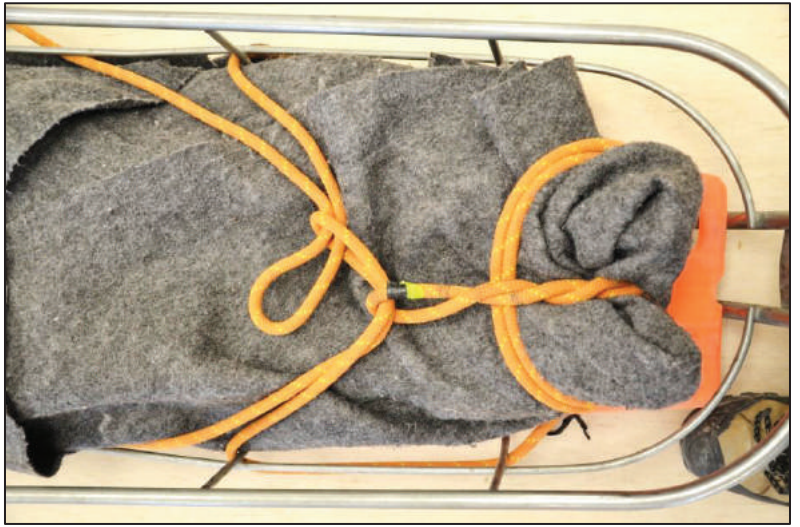

**5.** When you reach the top cross member, tighten each running end over the casualty's shoulders making sure they are well padded. Tie off on the stretcher frame with clove hitches.



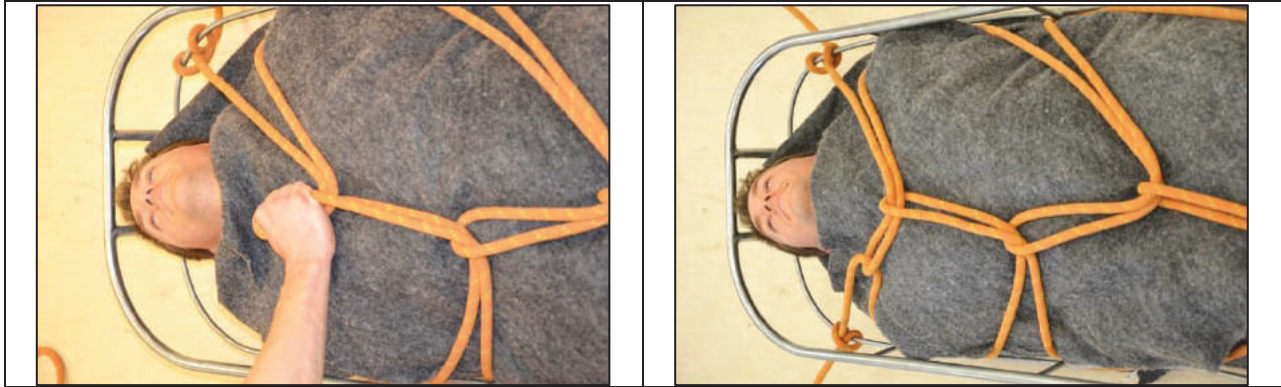

**6.** Check tightness of the whole tie-in starting at feet. Move final clove hitch towards stretcher cross member near casualty's shoulder or fully trap the knot by tying around both sides of it. Place left over rope or webbing under all to keep from falling out or interfering with rigging systems. Bottom Right: Tie-in using webbing.

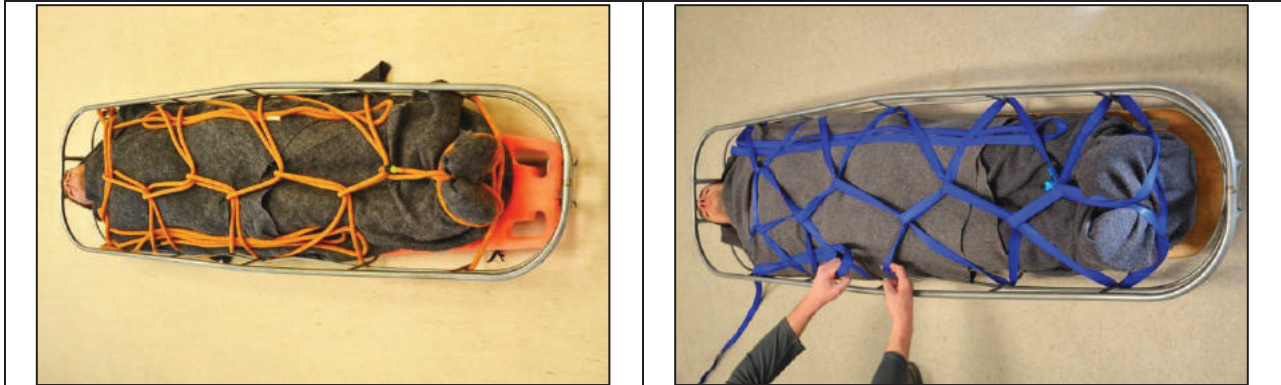

Releasing the herringbone basket stretcher tie-in to let patient out of stretcher:

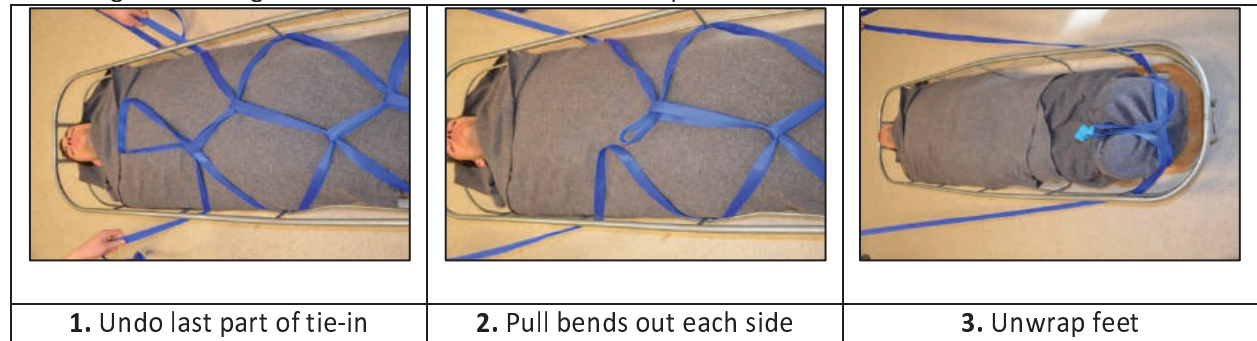

Example of trapping cross member with a clove hitch:



---

## Diamond Lashing

This method uses webbing to secure a casualty in a stretcher. It takes longer to remove from a stretcher than the herringbone method.

**1.** Start with an 18 m (60 ft) length of webbing (minimum diameter 25 mm). Fold in half and wrap around the centre of the top rung on the foot end of the stretcher.



**2.** Looking from the bottom of the stretcher, with the right tail go around the outside of the left foot and continue along the top of both feet to the opposite (right) foot, then go around and up through the middle. This tail will continue through to the left side when looking from the foot end of the stretcher.





**3.** Looking from the bottom of the stretcher, go around the outside of the right foot with the other web tail and continue along the top of both feet to the opposite (left) foot. Go around and up through the middle. This tail will continue through to the left side when looking from the foot end of the stretcher.



**4.** Both web tails will continue up to the opposite sides to the first rung on the stretcher incorporating the first post.



---

**5.** Continue to crisscross up the patient to the opposite sides of the stretcher creating diamonds across the body incorporating the posts. Always use the bottom rung.



**6.** The last cross should be across the chest area and over the shoulders to hold them down.



---

**7.** Continue to the head of the stretcher tying a clove hitch on the top rung, making sure to incorporate the post.



**8.** Repeat the same with the opposite side.







**9.** Secure the loose ends **OPTION:** Follow down the two sides tying half hitches.



**10.** When done the patient should be secured to the stretcher with no excessive slack in the webbing and patient should not be choked with the last cross on the chest. To test the system, lift the head end of the stretcher up to vertical, the patient should not drop within the lashing.

## Furley Stretcher Tie-In

This tie-in securely lashes a casualty to a furley stretcher.

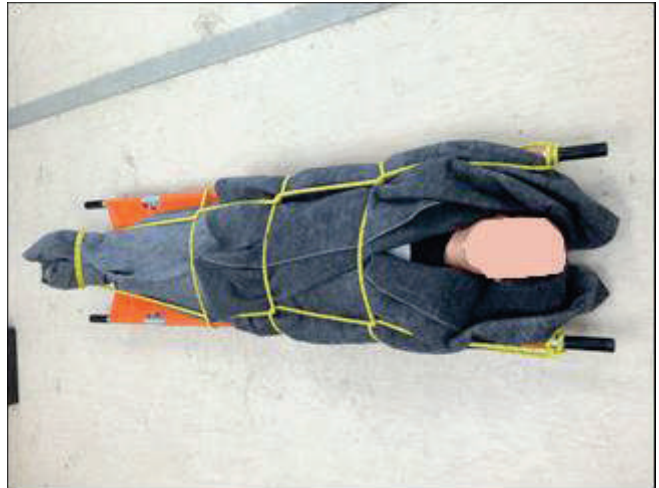

## Stretcher Bridle Examples

<p>Typical stretcher attachment tied with webbing</p>	<p>Attachment that works well for plastic baskets. The web tails can be used to secure an inner support piece such as a spine board.</p>	<p>Example of a commercially manufactured bridle</p>
<p>Commercially available stretcher attachments</p>		



---

## ANCHORS

High forces are often encountered during rope rescue operations. **Anchors** that are solid and unmovable relative to the load being applied (“bombproof”) are needed to connect the systems. Because it is often difficult to assess the strength of an anchor, rescuers should be incorporating two or more anchors into the system whenever possible.

**Anchor Leverage:** To reduce leverage on a vertical anchor, secure the anchor attachment close to the ground. Minimizing the effects of leverage will maximize the strength of the anchor.

**Critical Angle:** Sometimes, anchors will not be in line with the rescue. In these instances it might be necessary to build a bridle anchor from two anchor points. These angles will create vector forces on the chosen anchors. It is imperative mine rescuers understand these forces.

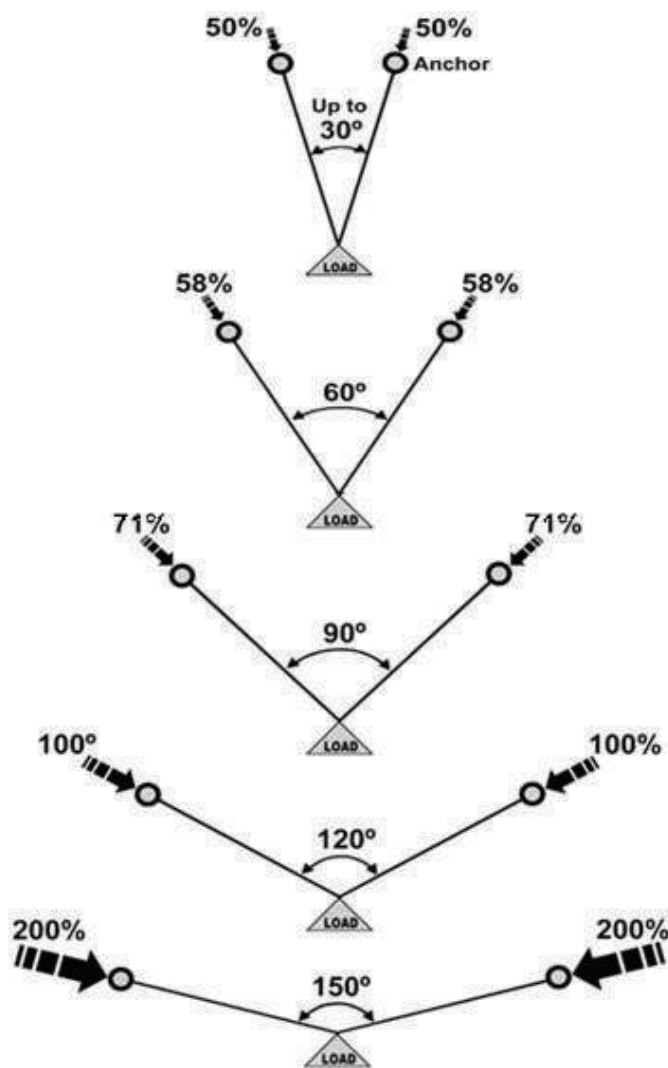

Fig. 11-1: Different angles and their respective vector forces

---

Anchors need to be examined by the team prior to attaching webbing or rope for:

- Location
- Strength
- Direction the load will be travelling
- Stability
- Sharp edges
- Abrasive surfaces
- Contaminants
- Hot surfaces
- Whether to use high or low anchor points
- Whether there is enough space to operate safely

### **Natural Anchors**

Trees are the most common anchors used by rescuers, but even large trees might not be suitable.

When selecting a tree to use as an anchor:

- Use large, healthy, and living trees.
- Make sure the tree is well rooted and doesn't rock.
- Use a tree with a diameter of more than 25 cm (10 in) if possible.
- Check the bottom of the tree where webbing or rope will be attached for things that might damage the anchoring material.
- Make sure the roots are not damaged and soil is undisturbed.

Rocky outcrops and boulders can provide a very strong anchor. When selecting rocky outcrops and boulders:

- Make sure they are large and stable enough for the load weight of the rope system.
- Make sure they are not fractured and shaped so that the web or rope won't slip up and off.
- Avoid sharp edges if possible. If that is not possible, add padding to the edges to protect the anchor system.
- Find level, stable ground not that does not slope downwards toward an edge.
- Avoid boulders sitting on a bed of smaller rocks as they can be moved with little force.

### **Structural Anchors**

Man-made structures can also be used as anchors. Examples of good structural anchors include:

- Reinforced concrete columns
- Steel I-beams larger than 15 cm (6 in) wide
- Engineered anchor points such as window washer fall protection
- Large brickworks

Examples of bad structural anchors include:

- Large pipes that are suspended primarily to support just their own weight
- Chimneys made from brick and mortar that are not made from vertically reinforced concrete.
- Surfaces with sharp edges that can damage attachment materials
- Structures or machinery capable of moving under load
- Unsound railings, ductwork, facades (face of building) or decorations
- Rusty moving anchor points

---

## Vehicular Anchor

Vehicles can be used if there are no suitable natural or structural anchors nearby. When selecting a vehicle:

- Use the largest and heaviest vehicle available.
- Park the vehicle at 90 degrees to the load direction if possible.
- Use a rescue vehicle with a dedicated anchor attachment point. Make sure the wheels are chocked and the emergency lights are on.
- Park the vehicle on a firm surface. Try to avoid wet or icy ground and loose gravel.
- Do not use bumpers, as they might be weak or have sharp edges.
- Do not use open toe hooks and trailer hitches. Instead, anchor to the vehicle frame.
- Remove keys and engage the park brake.
- Place a guard, sign or barricade around the vehicle.

## Underground Anchors

An anchor will depend on many factors including the mining methods used, the type of ground support, competency of the ground in the area and access to rock drills.

- For many rescue operations the quickest way to establish an anchor is to use a piece of mobile equipment. **Refer to vehicle anchor points for details.**
- In mines with threaded resin rebar or dywidag bolts, a D-nut can be used as an effective anchor. These simply attach to the end of the bolts, and very easily create multiple anchor points for a rescue operation.
- Floor pins can be used in production stopes with pre-drilled production holes in the floor. Floor pins can be manufactured onsite following an engineered design for the given load requirements. The floor pin is inserted into the pre-drilled hole and connections are made directly on the floor pin.
- When you have access to rock drills, you can drill holes to insert pins of cold rolled steel to create anchors. This type of anchor requires pre-planning as the correct angle for the hole has to be determined. Consideration of the competency of the rock is very important. Setting this up can take a lot of time to complete as part of a rescue operation.
- Mines that use split sets (friction bolts) as part of their ground support plans can use commercially manufactured anchors. Most are designed as fall protection anchor points which are rated for 5,000 lbf (22 kN).
- When establishing anchor points in underground environments, in many cases there are severe space limitations. For all underground anchors, establish the integrity and structure of the ground in which the anchor will be installed.

## Winter Anchors

Winter anchors are used in locations with lots of snow and ice. These anchors are site-specific, and require additional training beyond the scope of this manual.

## Anchor Attachments

Various methods exist for creating an anchor attachment point that connects to rope rigging systems. This is accomplished by wrapping webbing, ropes or using commercially made equipment such as rated wire slings or anchor straps. When using two or more rope systems, each system must be connected to an independent attachment point unless using an O-ring or multi-plate, as these can accommodate multiple attachments.



*Rated wire sling*

---

There may be cases where there is only a single bombproof anchor to use. When this happens, separate attachment points must be put in place. (Example: Two independent webbing wraps with their own separate connection points. Another method is to use a rated manufactured multi-anchor point plate.) Anchor attachment points can be extended from the bombproof anchor to a more favourable location for rigging. An example of this is adding an extension and making the anchor attachment point more accessible for rescuers working around the edge of a fall area. The rescuers can then connect their harness in the extended anchor point for fall protection or fall restraint.

### Rope Anchor Attachments

**Figure 8 follow through with a Figure 8 on a Bight:** Requires three feet of rope plus length needed to wrap around anchor. The Figure 8 on a Bight is the working end.

**Tensionless hitch:** Used on cylinder shaped anchors. Rope is wrapped three or more times. The anchor should be at least 10 times the rope's diameter. Use a figure of eight on a bight with a carabiner or a figure eight follow through to secure the loose end of the rope.

### Simple Slung (Single Loop)

Wrap a single strand of webbing around an anchor and join the ends with a ring bend. The ring bend will be extremely difficult to untie once loaded. When the internal angle of the sling legs is less than  $90^\circ$ , it can bear forces as high as 22 kN, which is only suitable for a single person load

### Basket Hitch

Keep the angle between the legs to less than  $45^\circ$ . Any greater angle may result in the carabiner being side-loaded. Not recommend for use where the direction of pull is changing because the legs of the hitch will not load evenly. This will significantly reduce its strength. It is suitable for a two-person or rescue-size load.

### Wrap-3-Pull-2

Wrap-3-Pull-2 is an anchor attachment that can be tied with webbing. Very little strength is lost when tied properly with the tied ends of the webbing facing the load and against the anchor.

### Advantages

- Allows carabiner to slide around equalize to avoid side loading.
- When tensioned, it cinches on to the tree to allow secure placement of high-point directional pulleys.

### Tying

1. Wrap three times around the anchor point.
2. Tie the long leg with an overhand trace back with the short leg to create a ring bend.
3. Position load side against the anchor point.
4. Pull the two unknotted loops forward and clip with a carabiner.



## Picket Anchor Systems

The picket system is one alternative when no anchors are available in a wilderness area. However, picket systems require a great deal of time to prepare for rescue use.

### Picket System Set-Up

1. The pickets should be 1 in (2.5 cm) diameter and have a length of 4–5 ft (1.2–1.5 m), so that there will be a minimum of  $\frac{2}{3}$  of the length in the ground.
2. Drive the pickets at an angle of 15 degrees away from the force to be anchored.
3. Connect the pickets in each row together by lashing from the top of the first picket (the one closest to the load with a clove hitch) to the bottom of the next picket three to four times and tie off at base. Continue in this manner until all rows of pickets are lashed together. Use 12.7-mm (1/2 in) rope or webbing approximately 50 ft (15 m) long.
4. Tension the lashings by twisting with a stick four to six turns. Drive this stick into the ground to secure it.
5. Connect the main line by clipping it to the front picket in each row.

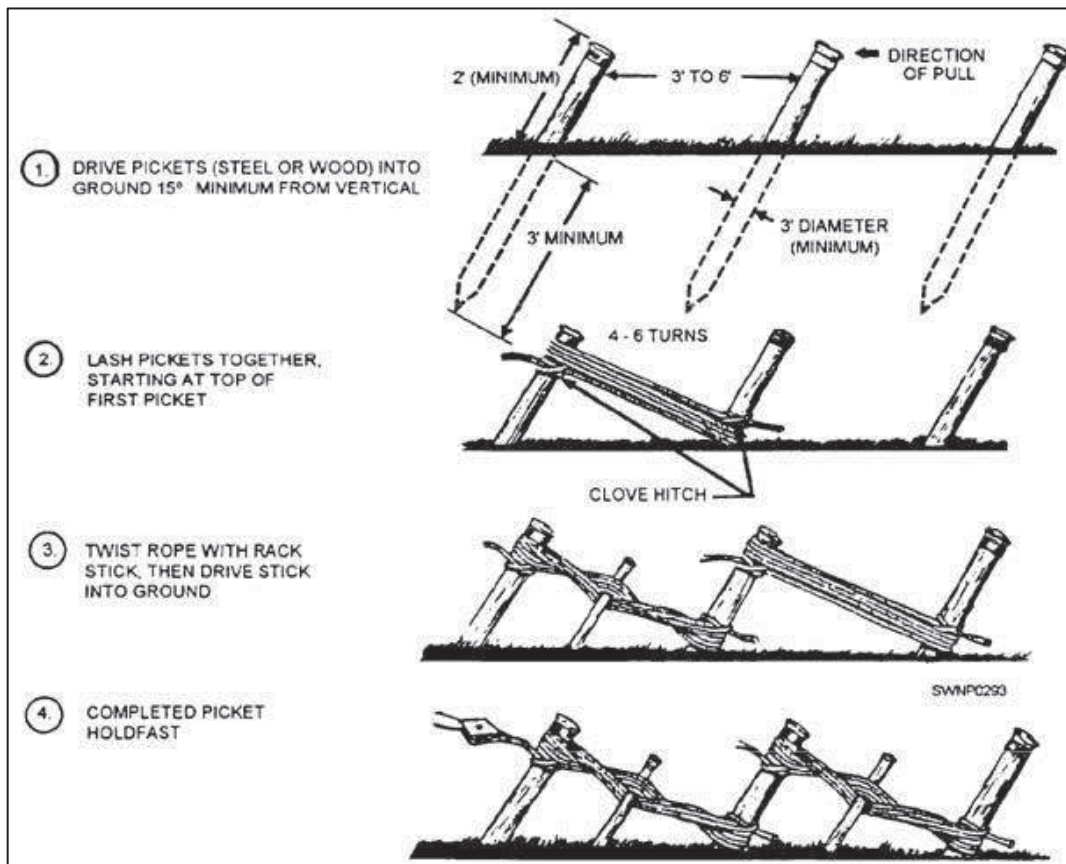

Multiple anchor points may be required to establish a bombproof anchor. Remember the 10:1 safety factor.

## MECHANICAL ADVANTAGES

Mechanical advantages (MA) are built by the use of pulleys and ropes. They are used in rescue operations where a load needs to be lifted. MA pulley systems assist in raising loads by reducing the amount of force needed. For example, a system with a MA of 5:1 requires only a fifth of the force used in a 1:1 system. This MA will require five times more length of rope to be pulled (pulling a rope five metres in a 5:1 pulley system will move the load one metre).

**Simple** systems use ropes attached directly to the load or anchor while the other end of the rope is where to apply the force to move the load.

- The MA will always be an odd number when the rope is tied to the load. It will be even when tied to the anchor.
- An easy method to determine the MA of a simple pulley system is to count how many ropes are used in the system. **Note:** If the final rope is being pulled in the opposite direction of the load travel, it is considered a change of direction and is not counted toward the calculation of the total MA.
- Make certain that pulleys are aligned and avoid having a rope crossover within the MA causing friction or twisting. Simple systems with a MA of more than 5:1 are more likely to encounter this problem and should be avoided if possible. In these circumstances consider a compound system.

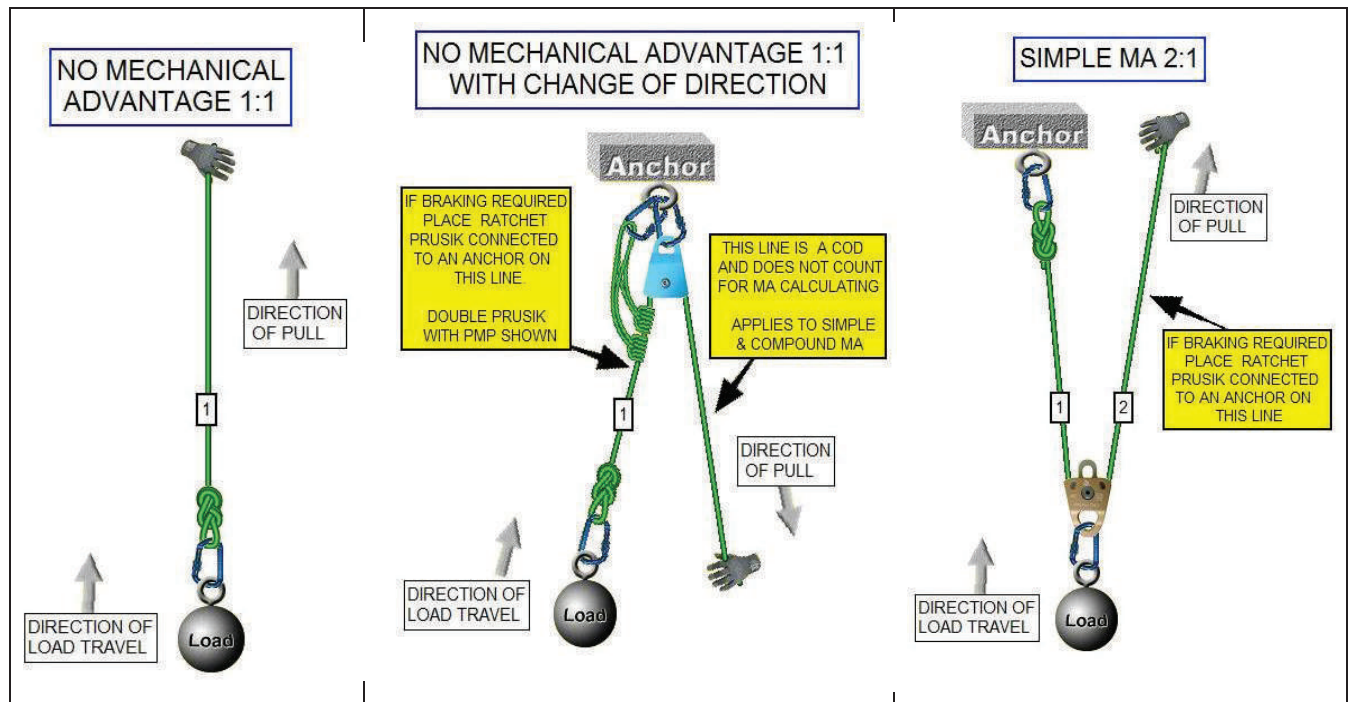

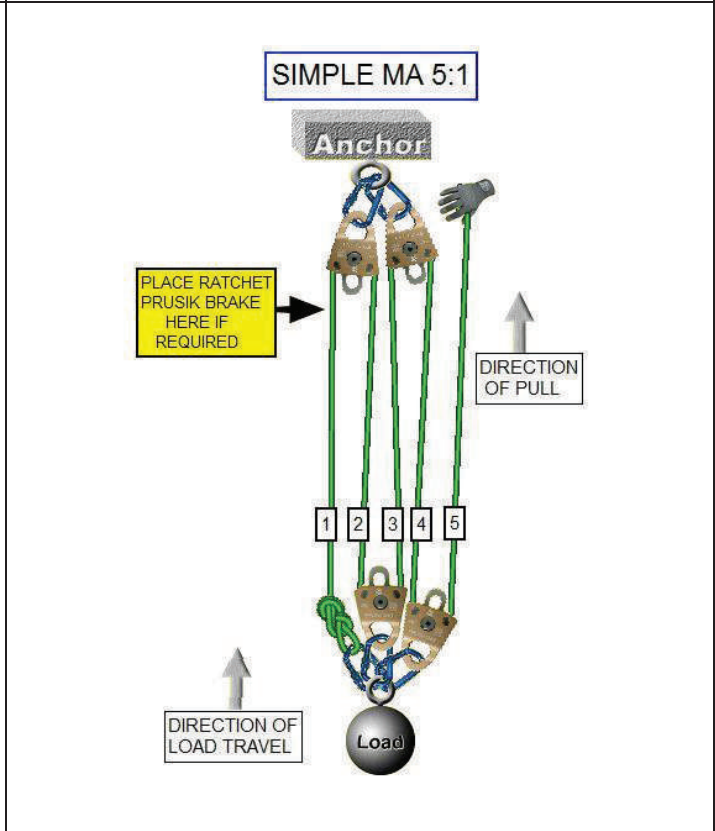
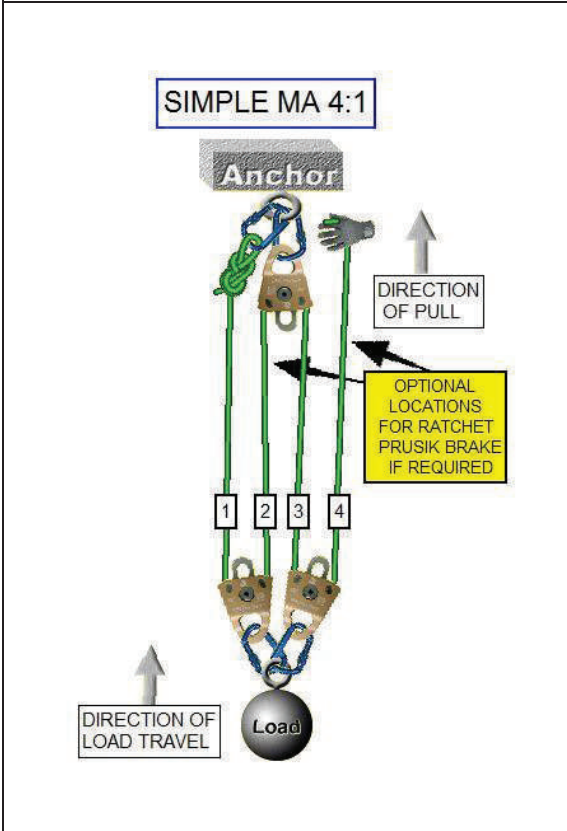
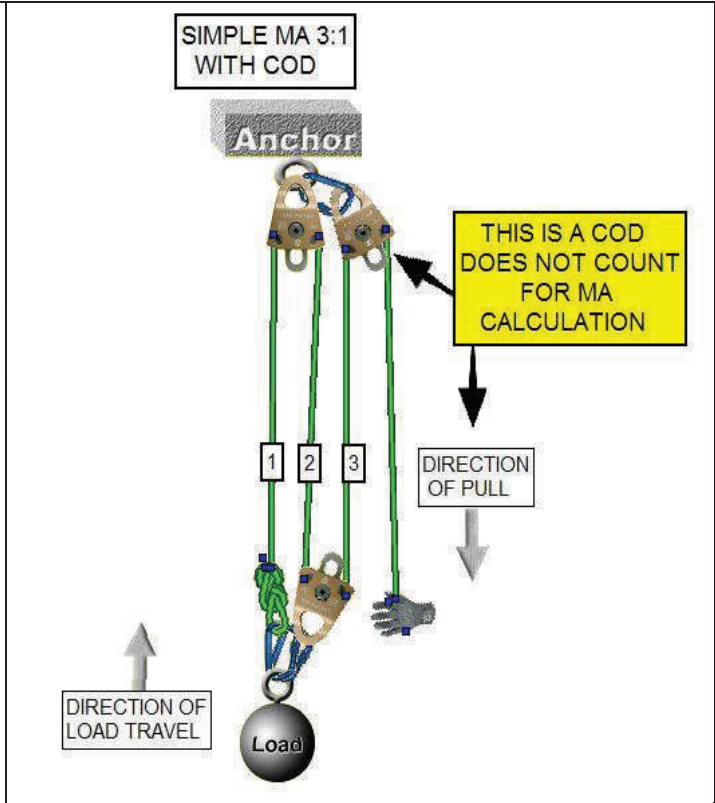
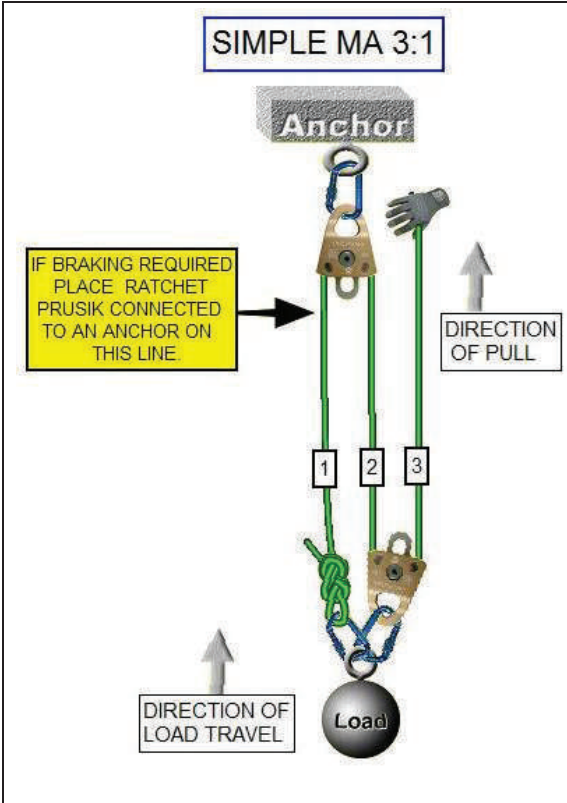



## Prusiks

The **prusik grab point** (or haul prusik) is the prusik wrap that attaches one MA to another in compound systems and allows one to pull the other. Placed in a Z-Rig, it allows a mechanical advantage to pull on itself (same rope). It is the component that slides for a reset when the pulleys become chocked (too close together). Only one prusik of 8mm or 9mm is used for this operation. A slipping prusik is a good indicator of excessive forces being applied in the system. Some mechanical rope grab devices can cause damage to rope, if using manufacturer procedures must be followed.

A **ratchet prusik** is placed in a haul system to safely hold a load (park brake) while resetting the pulling mechanical advantage in compound and Z-Rig setups. It also acts as a safety on the haul line. For large loads (> one person 300 lbs (136 kg)), use tandem prusiks. Adding a prusik minding pulley allows the prusiks on the haul line to operate the same as a Tandem Prusik Safety Belay when raising a load. There are commercial devices available that provide the same functions of this rigging.

**Compound** systems add a second or more pulley systems to the first pulley system (MA pulling a MA).

- To determine the MA of a compound system, multiply the MA of the two systems to determine the total MA. E.g., if one system is 3:1 and the other is 2:1, the total MA is 6:1 (3x2).
- If resetting a compound pulley system in which the two systems have different Mas, attach the system with a lower MA to the load and pull this with the higher MA. In some circumstances this rule of thumb will not work for the task at hand.
- Ideally separate anchors are used for each MA, spread apart by a metre or more.

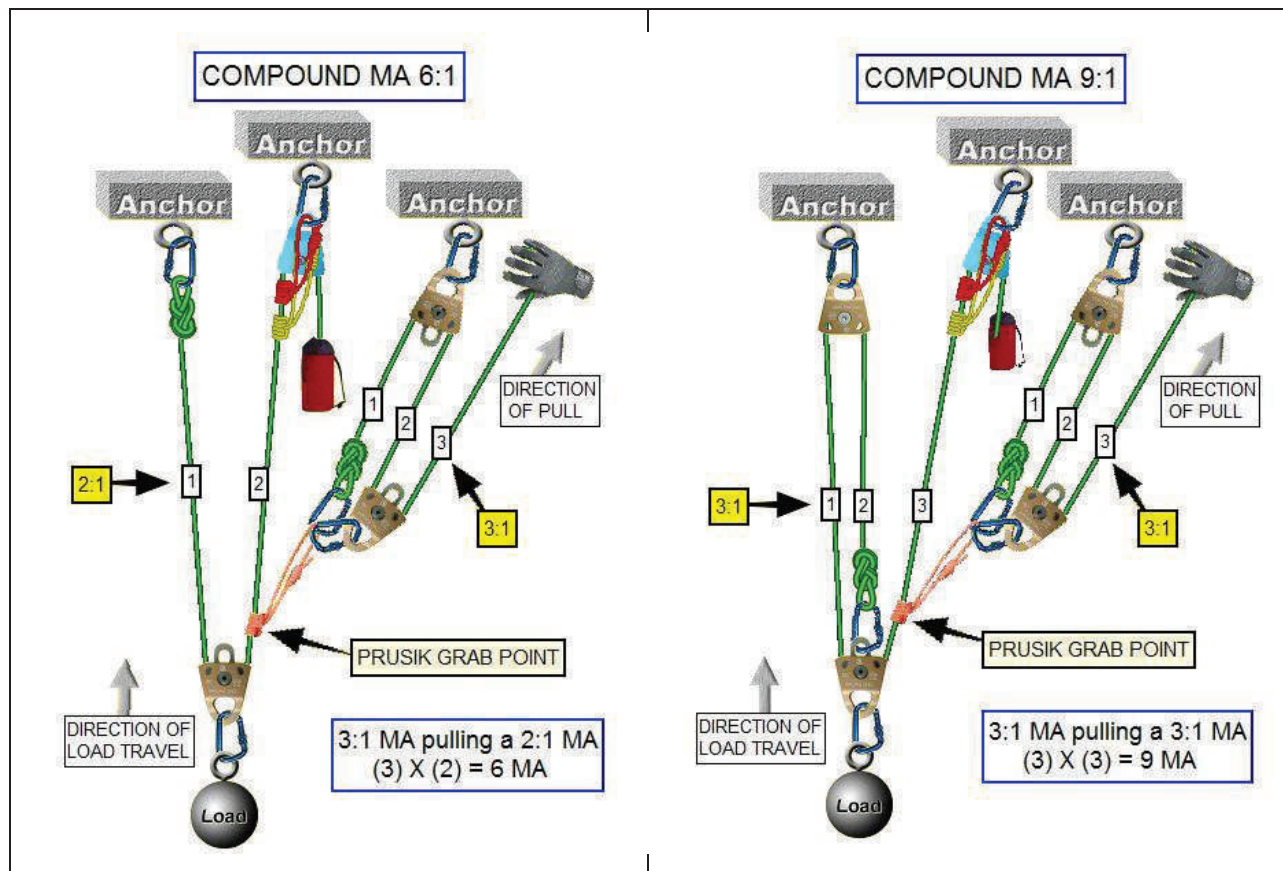



## Z-Rig Mechanical Advantage Systems

Z-Rigs are used extensively in rope rescue systems. A Z-Rig MA is a 3:1 MA made with a single rope and can easily be changed to a higher MA. The Z-rig gets its name from the shape it forms when constructed.

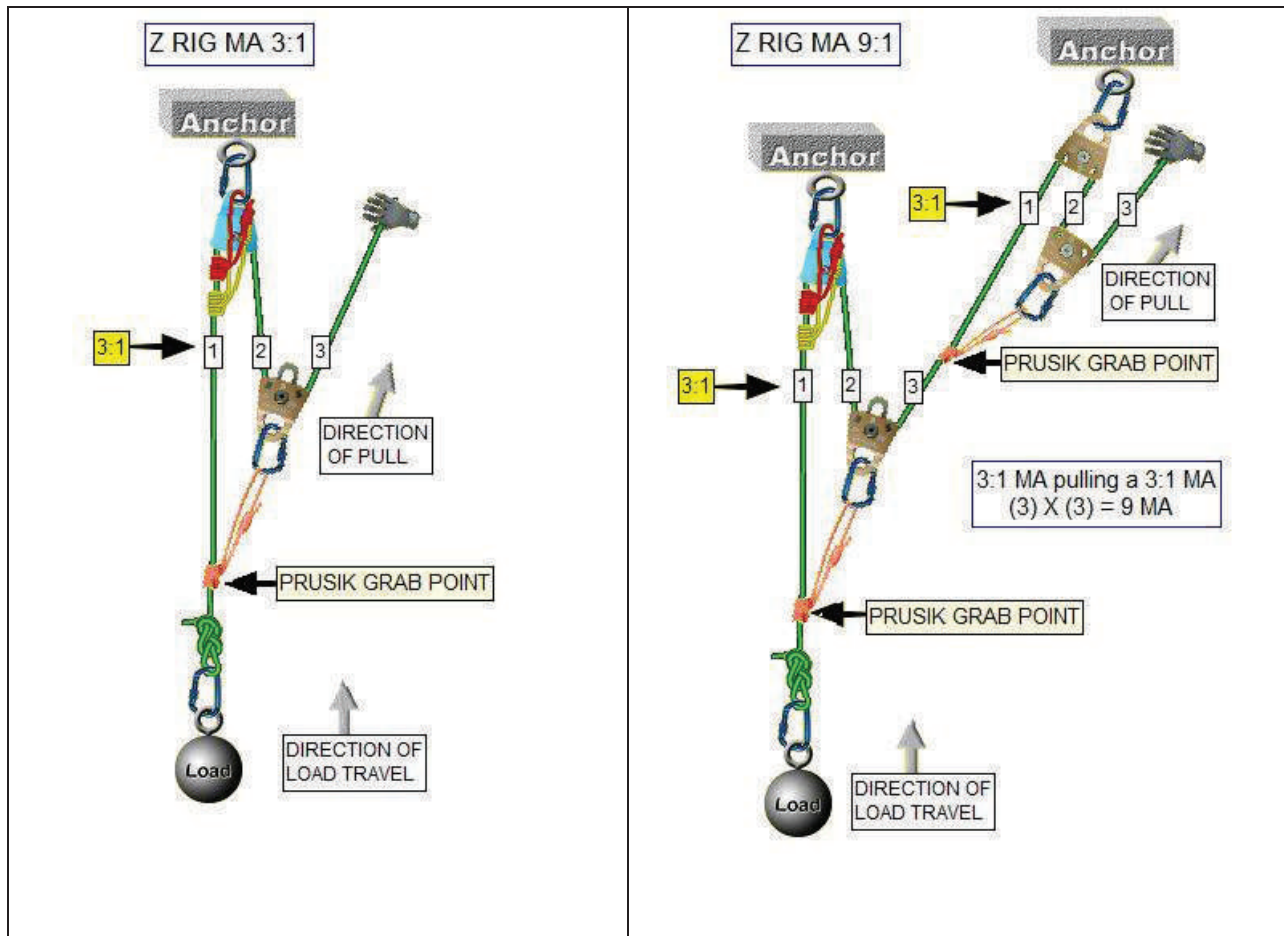

---

### Complex Mechanical Advantage Systems

A **complex** MA system involves combining two simple MA systems so that the travelling pulleys collapse together. The main advantage of complex systems is that they need less equipment to accomplish a larger MA.

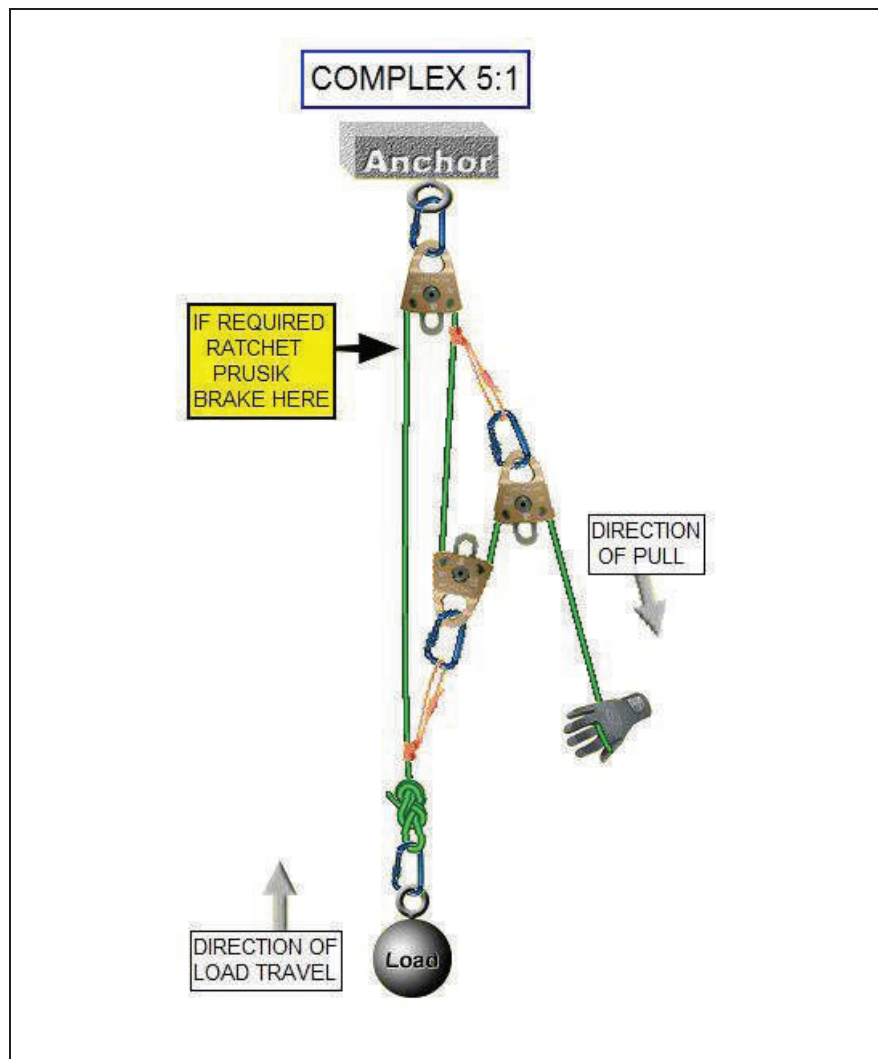

## Change of Direction

A **change of direction (COD)** within a MA is where the pulling force on the rope end is traveling in the opposite direction of the load travel. Example: Pulling downwards on a MA while the load is traveling upwards.

In some rope rigging situations, a COD pulley on a separate bombproof anchor might be required. (If the distance between a highpoint COD and the ground creates a drop high enough to cause harm, then the rigging should be run at ground level.)

Examples of when to use a COD:

- Structural situations where a COD is needed because of limited space to rig
- Situations where the main anchor point causes the haul line to not align with the load
- For embankment-type rescues where MA hauling and reset distances are limited
- Using building support beams as High Directional Anchor (HDA)
- Rigging for a cliff or severe edge where a high point is needed, such as on an A frame.

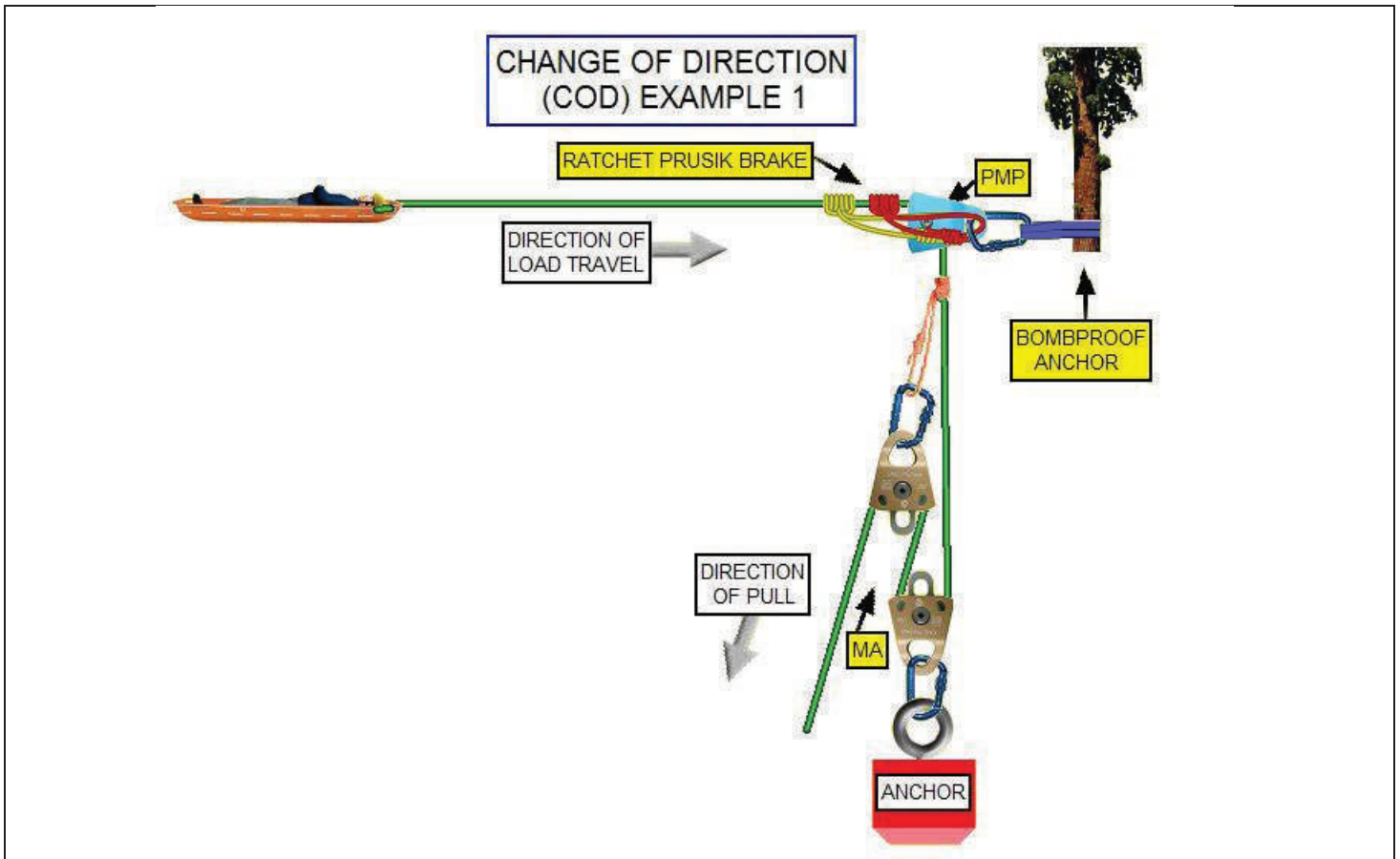

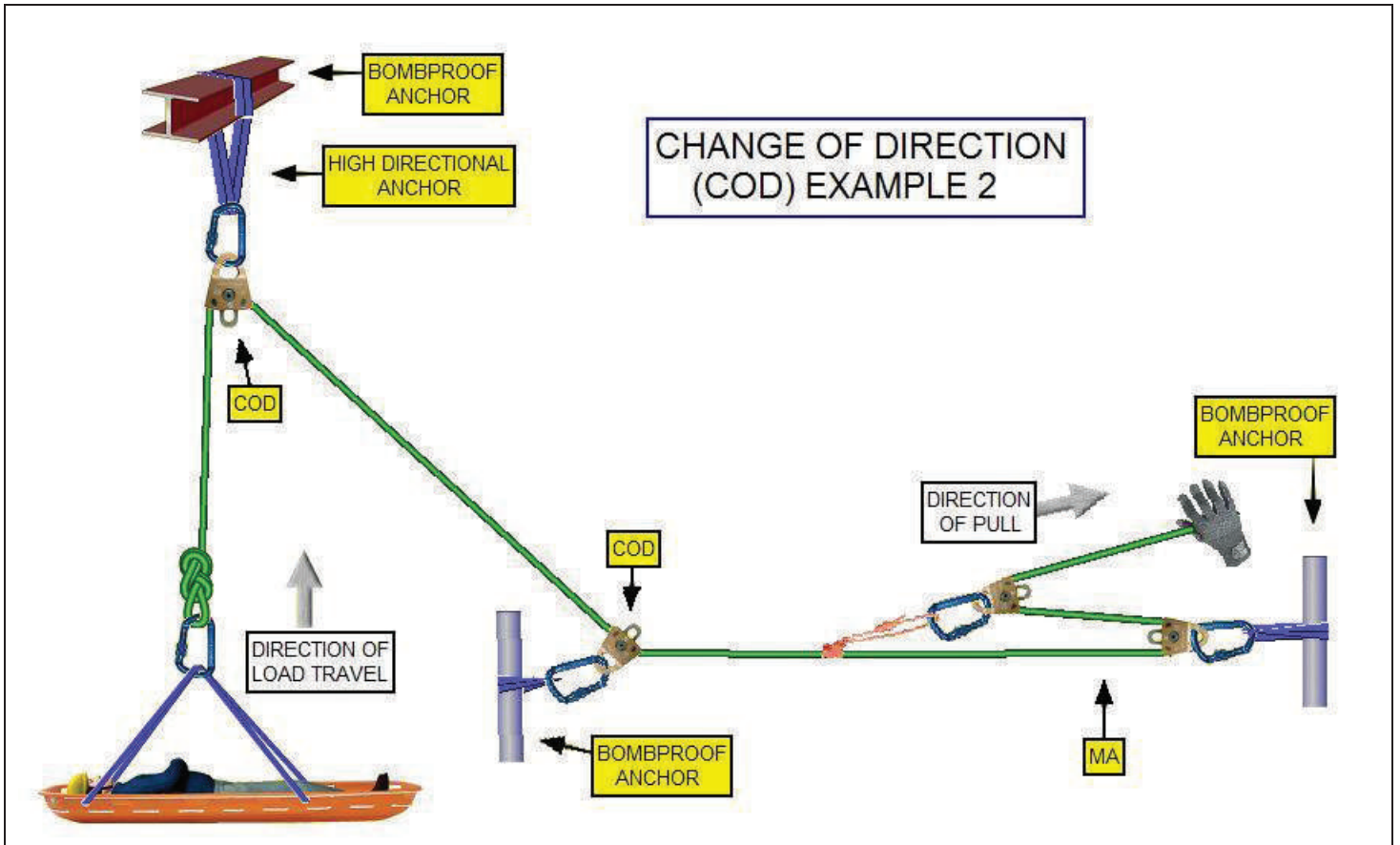

### Large Mechanical Advantage Systems

Most rescues can be accomplished with a 6:1 pulley system. 8:1 and 9:1 systems are generally not recommended because of the amount of rope and space required. They also have less “feel” for the load being pulled, leading to too much force being exerted and potentially damaging the system. Safe working loads of rigging equipment must be considered in terms of force applied by these larger MAs.

### Rescuer Pulling Force

The average rescuer can pull with a maximum force of 23 kg (55 lbs). Before using a pulley system, calculate roughly how much force will be exerted by the rescuers and the MA. A prusik will slip at around 500 kg (1100 lbs). Rescuers need to do a system check and re-examine the load weight including the pulling forces being applied when this occurs.

### BELAYS

Belaying is used to protect a person or load from falling. Some methods are designed for light loads, such as a single person. For heavier loads, rescuers use a **safety belay system**.

Munter Belay techniques can be used for a single person safety line on low-angle consolidated slope. The advantage is quick setup in situations where a critical casualty requires immediate first aid.

**Munter belay techniques are not to be used for any technical rescue operations, such as high-structural or cliff rescues, in which a serious fall could occur. These belay methods do not pass the Whistle Test: If, in theory, at any point a whistle were blown that signals all personnel to stop and remove their hands from the system, nothing catastrophic will occur to the live load.**

### Safety Belay Systems

Main rope rescue lines can fail due to equipment failure, human error or environmental conditions. The best practice for mine rescue rope rigging is the use of a second independent rope system as a back-up when lowering or raising loads.

Functions of a safety belay system:

- Catches the load of the main line if it fails without an operator to engage it. Normally the safety belay system should never come under tension unless there has been a failure. (**Note:** The use of two-line systems with each line acting as both load and safety belay are used in some rescue operations. This technique requires specific training and is not included in this manual.)
- Must be able to survive the event sufficiently undamaged and allow load to move up or down.
- The Maximum Arrest Force (MAF) must not cause injury to the rescuer or casualty, nor may it cause a system failure such as pulling out an anchor or cutting the rope on an edge.
- The stopping distance must be short enough to prevent the load from hitting obstacles.
- Must work in any environment.
- Rescuers must be able to operate the load under tension after it has been engaged with a load-releasing hitch.

**A variety of belaying equipment is commercially available. If any equipment used is not mentioned in this manual, please follow the manufacturer's recommendations to avoid misuse.**

### Belay Operation

1. The Prusiks should be held together in one hand in a thumbless grip (belay hand), to facilitate releasing. The thumb does not wrap around the Prusiks.
2. The hand should be held thumb up and with the opening towards the load by twisting the wrist. This wrist-twisting allows the belayer to monitor the amount of slack in the belay rope so that it can be kept to a minimum without the Prusiks accidentally grabbing. It also positions the Prusiks 90° to the direction of the belay line which aids in their ability to grab.
3. The second hand is used to pull the belay rope up through the Prusiks held in the belay hand.
4. Make sure the Prusiks remain snug on the rope through the operation.

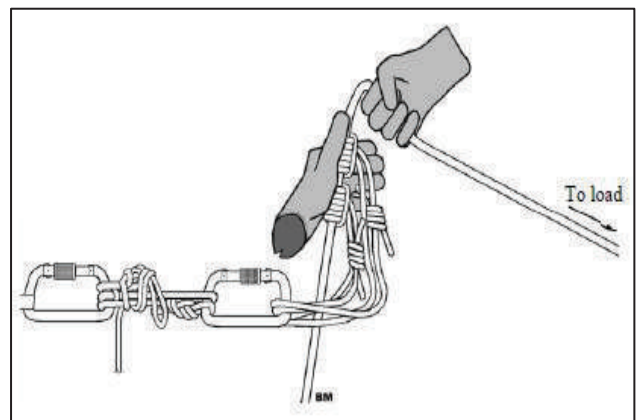

- In the event of a failure of the load system the pull of the belay rope should snap the Prusiks out of the operator's hands and allow them to grab quickly and without the belayer having to do anything.

### Radium Release Hitch

The radium release hitch is designed for releasing loads on ropes such as jammed safety belay prusiks and passing knots in the main line system during lowers. They are also used when you need to be able to lower a leading-edge directional pulley to allow a load to pass.

Use two large locking 'D'-shaped carabiners and a 10-m length of 8-mm cordage.

- Place two carabiners on the ground with the gates facing right, claws facing the position of function bottom down, top up.
- Tie a small figure eight-on-a-bight in one end of the cord and clip it into the load-side of the carabiner.
- Wrap the top carbiner and then (3) back down through the load carabiner, then back up to the anchor carabiner and incorporating a (4-5) Munter hitch on that carabiner on its gate side.

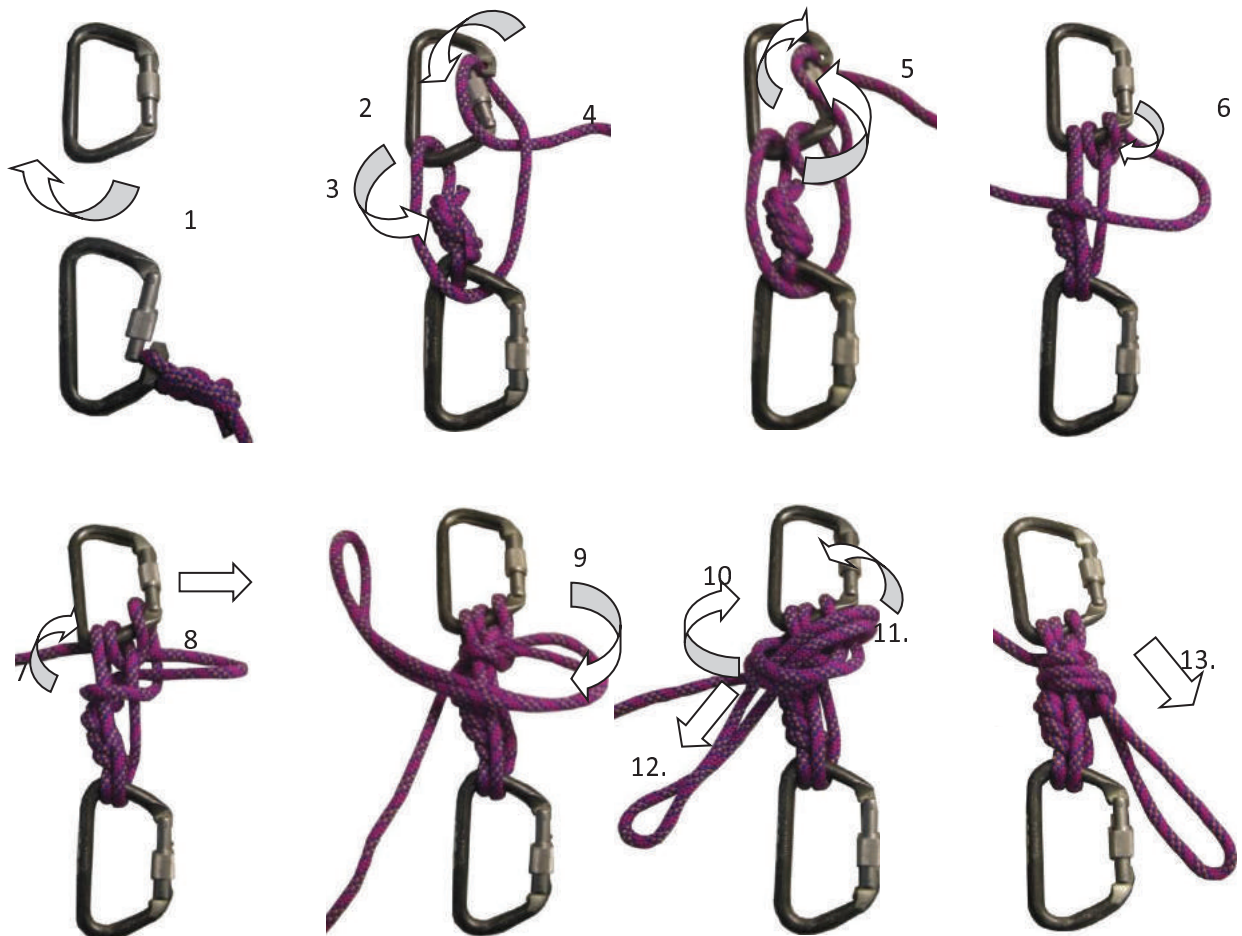

- Complete the Munter hitch wrap around all of the cordage strands (6-7). Pull a long loop through the bight created (8), and snug this up tight against the Munter.
- Ensure that the Munter hitch is in the release position with the in-feed rope on the gate side of the carabiner. Secure with an overhand safety around the entire stem. (9-13)

---

### Tandem Prusik Safety Belay

The tandem prusik belay system is designed to capture rescue-size loads. It also incorporates a load releasing hitch (Radium Release Hitch). A single prusik will slip if overly loaded and the spacing between the wraps allows them both to work without interfering with each other.

#### Components of a Prusik Safety Belay

- A Radium Release Hitch attached to the anchor attachment point. The Munter hitch is on the anchor side
- A Prusik Minding Pulley (PMP) attached to the release hitch. **Note:** Not required for a lowering operation but very beneficial when retrieving, such as when raising rigging.
- A short prusik approx. 5 ft (1.5 m) long and a long prusik approx. 6 ft (1.8 m) long attached to load release connection and then both triple prusik wrapped around the belay rope. The shorter prusik is set closer to the anchor with approximately two fingers to a hand-width of space between its wraps and the second longer prusik wraps. Note: These lengths work well for 2-in (5-cm) or 3-in (7.5-cm) PMPs.

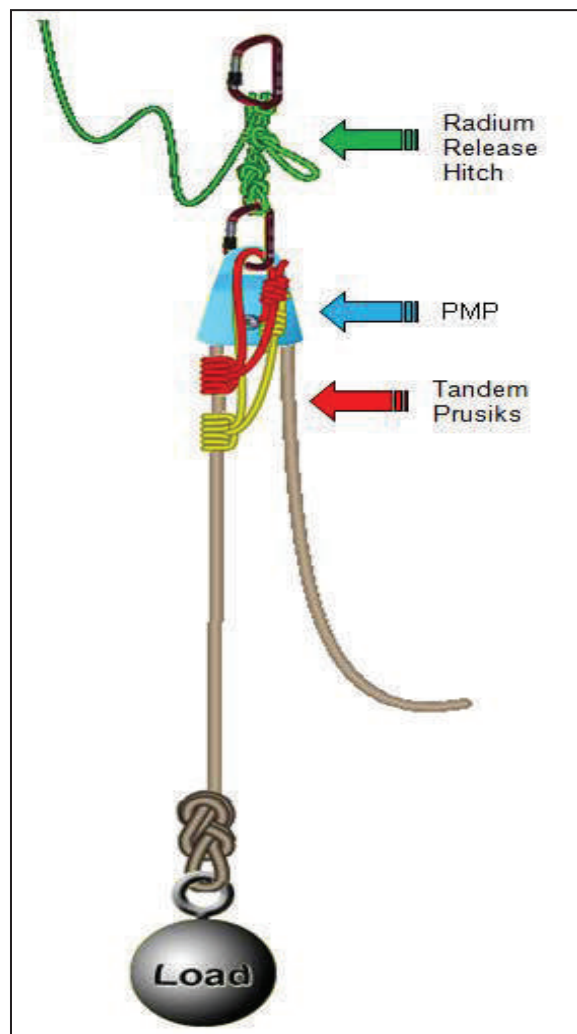

---

## RAPPELLING

Rappelling is the act of descending a rope with the use of a descent control device operated by the rescuer. There are many devices that can be used for this but most rescue teams use a “personal” brake bar or micro rack. There are various other commercial devices designed for this application. The descending device is connected to the rescuer’s harness with a locking carabiner.

For mine rescue rappelling operations over 30-degree (steep or high) angles, a safety belay line must be connected from a separate bombproof anchor point to the rappelling rescuer’s harness. The belay system must include tandem prusiks or an approved commercial belay device.

Rescuers must be trained and competent in using the device and be able to stop part way in the descent and able to either use a tie-off procedure or a locking mechanism in some devices. Dangerous errors include using an inappropriate reeve of the rope on a brake bar and inserting rope in the wrong direction in a commercial descent device.

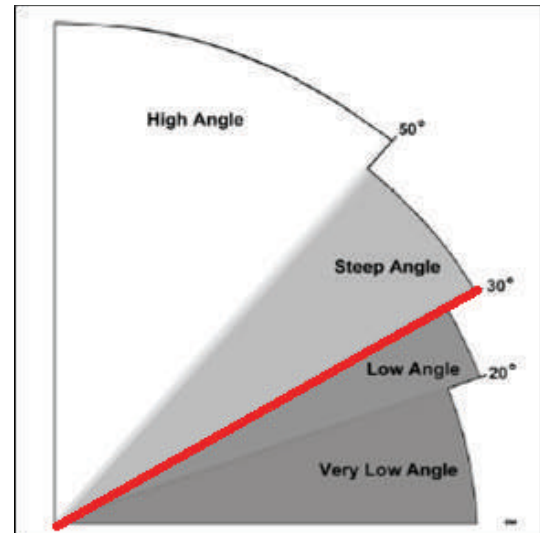

### Before Beginning a Rappelling Operation

- Completely check anchors, rope systems, attachment points, carabiner locks, rescuers harness and PPE.
- Ensure rappel distance does not exceed rope length.
- Connect the main line to the waist ‘D’ attachment. The belay is connected to the sternal (chest) or dorsal (back) attachment depending on the situation.
- Person assigned to operate and monitor the safety belay line must be ready to provide appropriate slack throughout and remain with that task until the rappel has been completed.
- Check that rescuers working near edges are on fall restraint or fall arrest rigging.
- Add edge protection to prevent rope damage, look for sharp or loose edge materials such as rocks and building flashings.
- Check the surface of the face that the rescuer will travel along for hazards, ice, slippery wet, loose materials, and snags.
- Consider rope stretch on initial load on rappel line at transition point (edge).
- Review rope angles. If a high anchor point is not available, the rappel person may have to crawl over edge to get set rather than use the “stand and lean back” rappel procedure.
- Check that the starting point is not directly over a hazard, casualty, or fellow rescuer.
- Avoid creating the potential for swinging by starting too far away from the direct line (vertical fall line) of rappel in relation to the anchor attachment point.



---

### **During Rappelling**

- Descending too fast can create problems such as high heat from friction or a loss of control by rescuer.
- Do not jump from side to side, as this can cause abrasions to the rope.
- Rescuers' leg stance depends on the type and shape of the footing surface. Good balance and avoiding foot slippage is critical. In general, rescuers should attempt to place their feet a small distance apart, approximately the same as shoulder width.
- If there is a rescuer on the ground, they can take control of the descent by controlling tension on the rappel rope from the bottom

### **Arriving at the Bottom**

- Bend knees slightly before stopping. Once down, stand upright.
- Disconnect rappel devices from rope. Leaving them on may subject the device to heat damage and there may be another rescuer that will be using this line.
- Disconnect from safety belay line.
- Notify Captain or rescue officer when off each line.





---

Western Canada Mine Rescue Manual

# Chapter 12 Underground Operations



---

## OBJECTIVES

Underground mining rescue operations present unique challenges and corresponding tactics. Upon completion of this chapter, the trainee shall be able to demonstrate knowledge of and/or competency in:

- Mine Emergency Response Plans (MERPs)
- Principles of underground mine ventilation
- Instruments used to measure mine ventilation
- Mine plans and sections
- Techniques used in underground firefighting

## A GUIDE FOR PLANNING MINE EMERGENCY PROCEDURES

### Safety

The primary goal of any mine rescue operation is to ensure the safety of the mine rescue team. Hazard identification and control are key components in a rescue operation. Due to the nature of underground operations, tactics such as controlling fire and ventilation may become a priority task to achieve the mine rescue principles.

**All mines are required to have a Mine Emergency Response Plan. Mine rescue teams need to be familiar with all the content in the plan and all must follow all on-site emergency procedures. This chapter is a guide to the components of an emergency response plan.**

### Emergency response system activation:

- **Initial Report of Emergency:** Discovery of emergency is relayed to designated personnel.
- **Initiation of Mine Emergency Response Plan:** Designated personnel receive the emergency report and initiate the mine emergency response plan.
- **Notification systems:** There are a variety of systems used to notify workers of an emergency, such as stench gas, radios/telephones, personal emergency devices (PEDs), and other audio and visual alarms.

### Organizational chart showing chain of command

Role	Responsibilities
Mine Manager	<ul style="list-style-type: none"><li>• All mine operations and incident response</li><li>• Ensures effective MERP is in place</li><li>• Liaises with jurisdictional authorities</li><li>• Delegates command</li></ul>
Mine Superintendent	<ul style="list-style-type: none"><li>• Knowledge of mine operations</li><li>• Accountability system (e.g., tag-in, tag-out)</li><li>• Liaison between mine manager and response structure</li><li>• Controls access to the mine</li></ul>
Plant/Maintenance Superintendent	<ul style="list-style-type: none"><li>• On-site support (e.g., electrical, mechanical, ventilation, water etc.)</li></ul>
Chief Engineer	<ul style="list-style-type: none"><li>• Mine plans and ventilation</li><li>• Technical advice</li></ul>

Emergency Response Co-ordinator	<ul style="list-style-type: none"> <li>Relays directions and observations between command centre and mine rescue teams</li> </ul>
Rescue Teams /Specialists	<ul style="list-style-type: none"> <li>Respond within their capacity</li> <li>Take direction from emergency response co-ordinator and report back observations</li> <li>Maintenance of response equipment</li> </ul>
Medical Services	<ul style="list-style-type: none"> <li>Deal with any casualties brought to the surface</li> <li>Communicate directly with external medical support (ambulances, medical doctors, etc.)</li> <li>Communicate internally with command centre</li> </ul>
Logistics and Support	<ul style="list-style-type: none"> <li>All the services and support needs of an incident (transportation, lodging, food, costs, families, confidentiality and security)</li> <li>All outside liaisons (media)</li> <li>Obtains essential support personnel (Post-incident critical stress counseling, etc.)</li> <li>Maintains facilities, equipment and supplies</li> </ul>

**Escape routes and travelways:** Both primary and secondary routes must be clearly marked on mine plans and posted in strategic locations around the mine. These plans must be regularly updated and readily available to mine rescue personnel.

**Refuge stations:** A place where workers can isolate themselves from toxic gases, smoke and oxygen-deficient atmospheres. The locations and components of a refuge station are dictated by jurisdictional regulations. They can be:

- **Portable:** Are smaller and can be easily moved as production or development progresses.
- **Permanent:** Can accommodate more people due to their larger size and available air. They may become redundant as mine development progresses but still remain functional.

Workers and rescue teams must be familiar with:

- Refuge station locations in the mine
- Refuge station operating procedures
- Capacity of refuge station
- Equipment and furnishings, such as: Carbon dioxide absorbent, oxygen supply (cylinders or generators), heater/air conditioning, fire extinguishers, lighting, first aid supplies and stretcher, toilet facilities, sealing clay, etc.
- Duration and conservation of supplies, such as oxygen/air, water, food, battery capacity, etc.
- Communication procedures

**Rule of Thumb: Approximately one cubic metre of air will provide sufficient oxygen for an average person at rest for one hour. After one hour, the oxygen content will be approximately 16% and the carbon dioxide content will be approximately 5%.**

**Self-rescuer caches:** These caches will be found in various locations around the mine and contain a supply of self-rescuers. They are designed to assist escaping workers. They are also a resource to mine rescue teams.

---

**Ground conditions:** Identify and control hazardous ground conditions using techniques such as:

- Scaling: The sounding and removal of loose
- Temporary ground support: Erecting timber supports or other devices
- Barricading: Preventing access to areas that do not have adequate ground support

**Ventilation:** Rescuers need to understand normal mine ventilation and how it is affected by fire or failures in ventilation control.

**Power distribution, compressed air, and water distribution systems:** Rescuers may be accessing these systems in an emergency and must be familiar with their operation and isolation.

**Emergency Egress Procedures:** In the event that a worker reaches the surface during an emergency, they must check out of the mine using the established accountability system. They should then assemble in a designated area and should not leave until told to do so by a person in authority.

**Command/Emergency Operations Group:** Personnel designated under the mine emergency response plan for the direction, coordination, communication, and support of the emergency response.

## **FIRE CONTROL AND VENTILATION**

Underground mine fires are extremely hazardous situations with the potential for catastrophic loss of life and damage to the mine workings. Fire suppression underground requires particular skills and a solid understanding of the basic principles of mine ventilation. Even greater care is needed than in the case of surface fires to avoid rescue workers becoming casualties themselves.

### **Underground Mine Ventilation**

Underground mine ventilation is the primary engineering control used to provide respirable air and to reduce workers' exposure to hazardous atmospheres. Understanding mine ventilation will help mine rescue teams to safely advance into the mine during an emergency.

### **Factors Affecting Air Movement in a Mine**

**Pressure:** Horizontal air movements are caused by differences in air pressure. Air always moves from a high-pressure area to an area of lower pressure. The greater the pressure difference, the faster the air will move.

**Relative Weight:** A difference in relative weight (air = 1) also causes air to move, but movements caused by differences in weight are in the vertical direction.

**Temperature:** Hot air is lighter than cold air and rises. Cold air is heavier and will sink to lower places.

Air moves through a mine by two methods:

- Natural Ventilation
- Mechanical Ventilation

### Natural Ventilation

Some mines, especially those in mountainous terrain, have natural ventilation caused by differences in pressure inside and outside the mine and by differences in the relative weight of warm and cold air. While all mines with operating diesel equipment are required to use mechanical ventilation, a basic understanding of natural ventilation principles will assist in mine rescue operations.

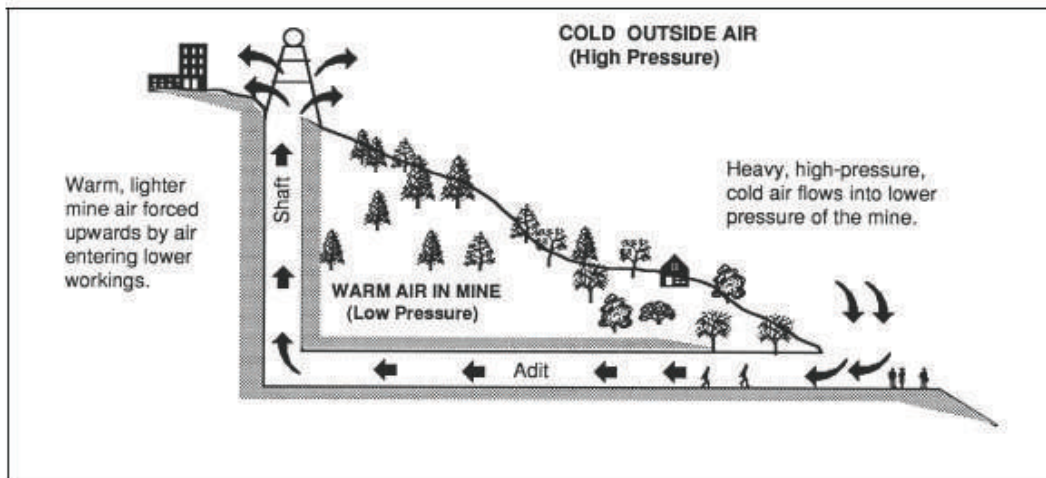
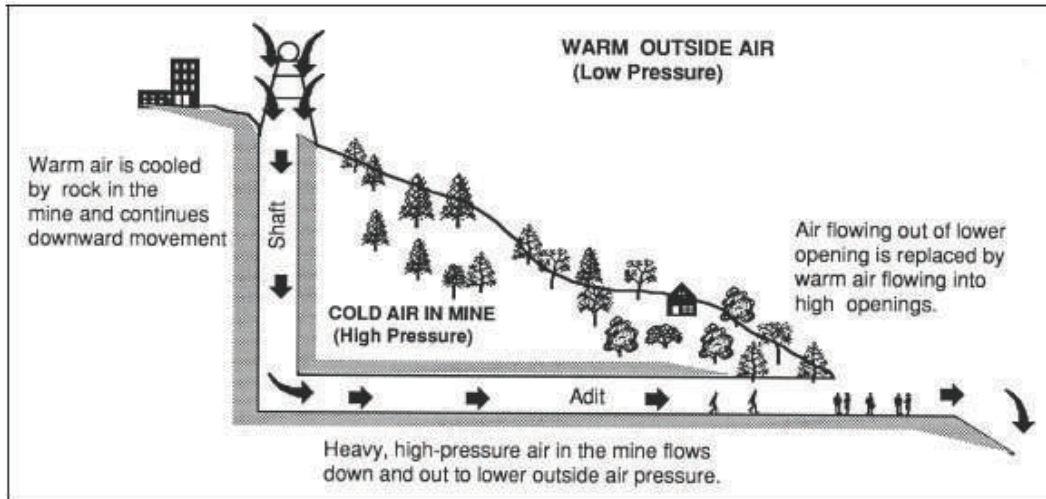

### Mechanical Ventilation

While natural mine ventilation can be very effective, it is not reliable. Mechanical ventilation is required when using internal combustion engines where a specific volume of air is required. This is accomplished by installing fans at mine openings or inside the mine. Mine fans are simply a means of changing the air pressure at specific points in the mine.





**Positive pressure ventilation** uses a fan to create a high-pressure zone. In underground operations, this is done by placing a fan at the entrance of a tunnel, facing inwards. The high-pressure air in front of the fan will flow to the lower pressure areas further from the fan. The scooping action of the fan blades prevents the air from flowing back through the fan.

**Push pull ventilation** involves combining a positive pressure fan and an exhaust fan to create a pressure difference that will increase the air flow.

**Auxiliary ventilation** is used to direct air flows from the main ventilation route to dead-end headings.

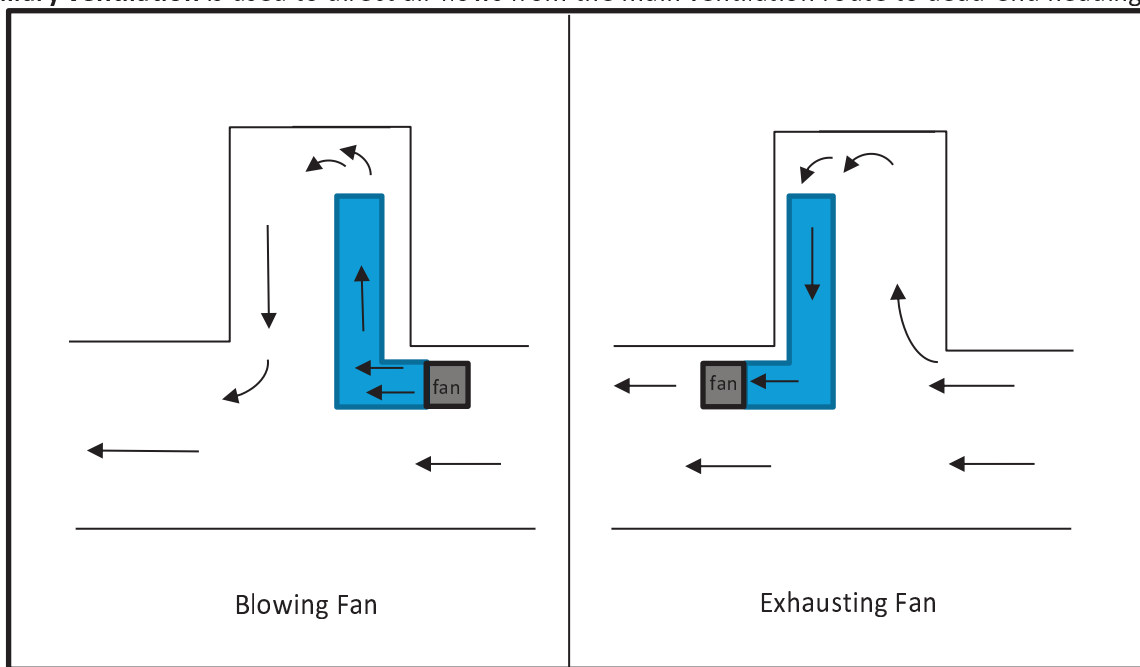

#### Air Distribution

*Fig 12.1: Blowing and Exhausting fans providing auxiliary ventilation*

As air flows through a mine it always takes the easiest path, that is, the path that offers the least resistance. The resistance to air flow is determined by:

- The amount of air passing
- The roughness of the openings it is passing through (friction)
- The size of the openings
- The length of the openings

Air will pass much more easily through a large diameter, smooth-walled tunnel than it will through a small diameter, heavily timbered tunnel. Restrictions in tunnels such as locomotives, trackless mining equipment, conveyors, ventilation regulators, etc., will add to the resistance of a mine opening and make it more difficult for air to pass.



---

## Splits

When air flowing through a mine working comes to a place where it branches into two or more openings, the air will split and some will flow through each opening. The amount that flows in each direction will be determined by the effective resistance in each opening. Air will not flow into dead-end drifts as it has nowhere to go.

The most common methods of routing air to where it is required are:

- Ventilation stoppings and doors
- Ventilation regulators
- Auxiliary fans (Booster fans)
- Auxiliary fans with ventilation ducting
- Line brattices

## Ventilation Stoppings and Doors

Ventilation stoppings and doors can be used to stop air from going where it is not wanted and forcing it to go where it is needed. When main fans are installed in a mine, they are offset from the main mine entrance. Airlocks are used to overcome the pressure created by the fans and to facilitate access and egress. It is important that doors be kept in their proper positions so as not to interrupt or change ventilation in the mine.

**Solid stoppings** (bulkheads) are used when access is not required; doors in bulkheads are used when access is required. There are many ways in which stoppings and doors are used to route air through mines. Their main function is to isolate high-pressure areas from low-pressure areas where air is not required. A partially opened door can also be used for this purpose.

A **regulator** is a solid stopping with an adjustable opening in it. They are used to reduce the amount of air passing through openings by increasing the amount of resistance. Doing so increases the amount of air passing through other airways. Settings are not to be changed by unauthorized personnel.

**Fire doors** are used to control air flows in the event of mine fires and at such times they serve the same purpose as stoppings or ventilation doors. Fire doors are often built at strategic locations in mines, such as at shaft stations, shop areas, and fueling bases. In the event of fire they are closed so as to isolate sections of the mine. If installed fire doors must be kept clear of obstructions and in working condition at all times.

**Auxiliary fans** are often set in places where it is necessary to increase air pressure to force air through workings that are otherwise difficult to ventilate. The auxiliary fan forces relatively large quantities of fresh air through a drift where it carries dust and blasting smoke out to the ventilation exhaust system.

**Line brattice** is a partition made of Fabrine or burlap used to provide auxiliary ventilation. It is hung from roof (back) to floor to create a second air path in a dead-end heading.

## INSTRUMENTS USED IN VENTILATION WORK

<p>A <b>manometer</b> is a U-shaped transparent tube partially filled with liquid used to determine pressure differentials across a stopping or bulkhead (wall of a refuge station). The difference in fluid height in a liquid column manometer is proportional to the pressure difference.</p>	
<p>An <b>anemometer</b> is used to measure air velocity. It consists of a small fan that is rotated by the air current. The instrument is calibrated so that each revolution of the vane corresponds to a unit of air travel.</p>	
<p>A <b>velometer</b> is a small direct reading instrument used to measure the velocity of air at a specific point. Pressure exerted on a vane travelling in a circular tunnel causes a pointer to indicate the velocity of air moving through mine workings. The following formula is used to calculate the volume of air and its flow:</p> <p style="text-align: center;"><b>Volume Calculation</b></p> $\text{Height (m)} \times \text{Width (m)} \times \text{Velometer Reading (velocity } \frac{m}{s} \text{)}$ $= \text{Volume of Air (cubic metres per second)}$ <p style="text-align: center;">E.g., 3 m x 5 m x 3 m/s = 45 m<sup>3</sup>/s</p>	
<p><b>Smoke tubes</b> are used to measure low ventilation flows that cannot be detected with a velometer or anemometer. They provide an indication of air movement over distance. To determine the velocity, choose a set distance (e.g., 50 m, 100 m) and measure the time it takes for the smoke to travel that distance. Once that data is recorded, use the volume calculation formula.</p>	
<p>A <b>barometer</b> is an instrument used to measure the pressure of the atmosphere. A rapid fall in the barometer indicates a decrease in the atmospheric pressure that in turn decreases the mine ventilating pressure. This would allow the gases in gobs and abandoned workings to expand and flow into the active workings, creating a dangerous condition.</p>	

## MINE DRAWINGS

Maintaining up-to-date drawings of mine workings is essential for the day-to-day operation of a mine. Drawings for use by mine rescue teams should show at a minimum the locations of shafts, travelways, electrical systems, working places, refuge stations, and ventilation flows. This information is integral to mine rescue response. Three types of mine drawings are commonly used:

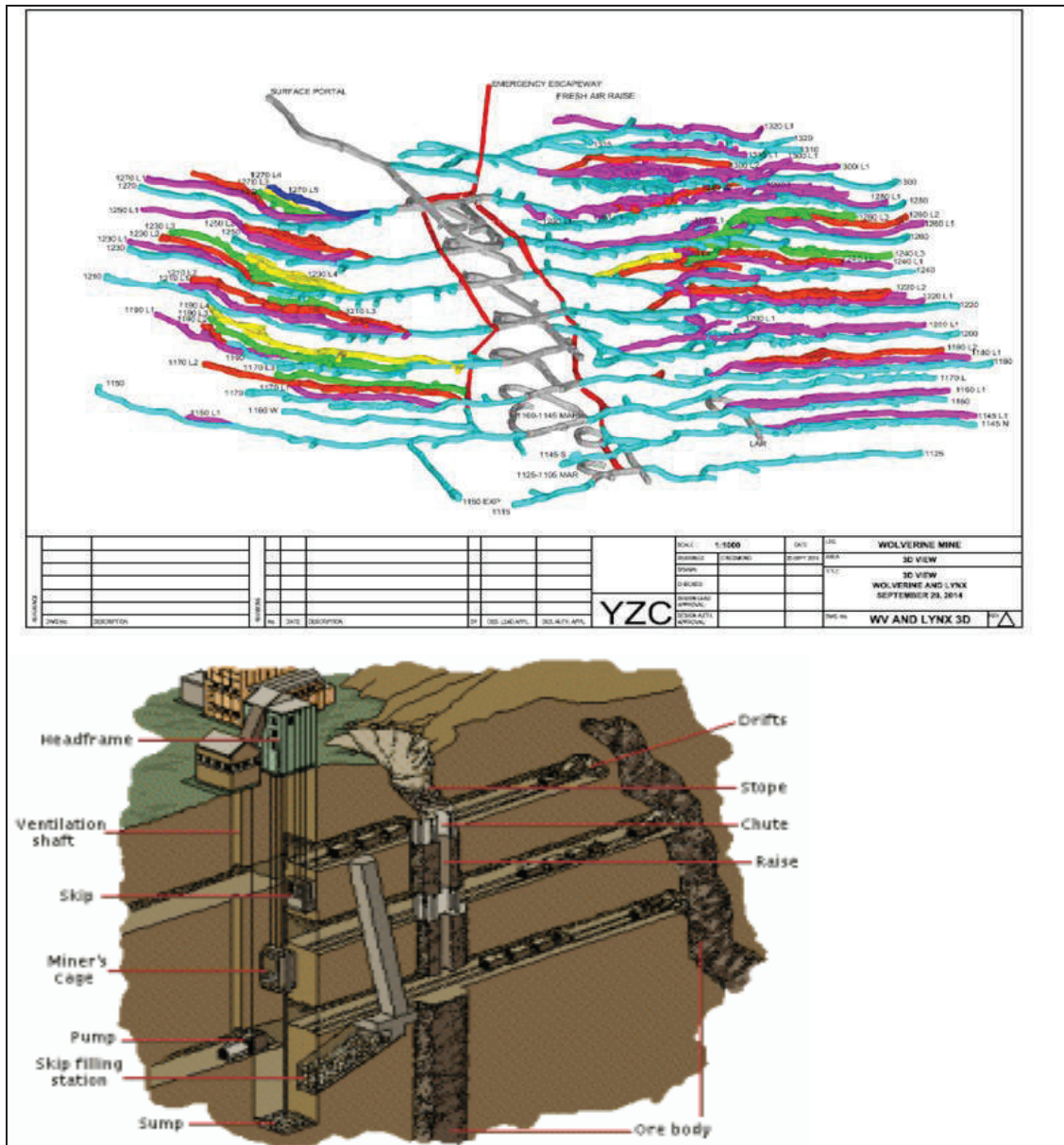

**Isometric drawings** are three-dimensional pictures of the mine workings. It shows what the workings would look like if all the rock surrounding the mine openings was transparent. With the advent of trackless mining methods using inclined and spiral ramps, normal mine drawings become quite difficult to read unless you are familiar with the mine layout, whereas isometric drawings provide a quick overview.

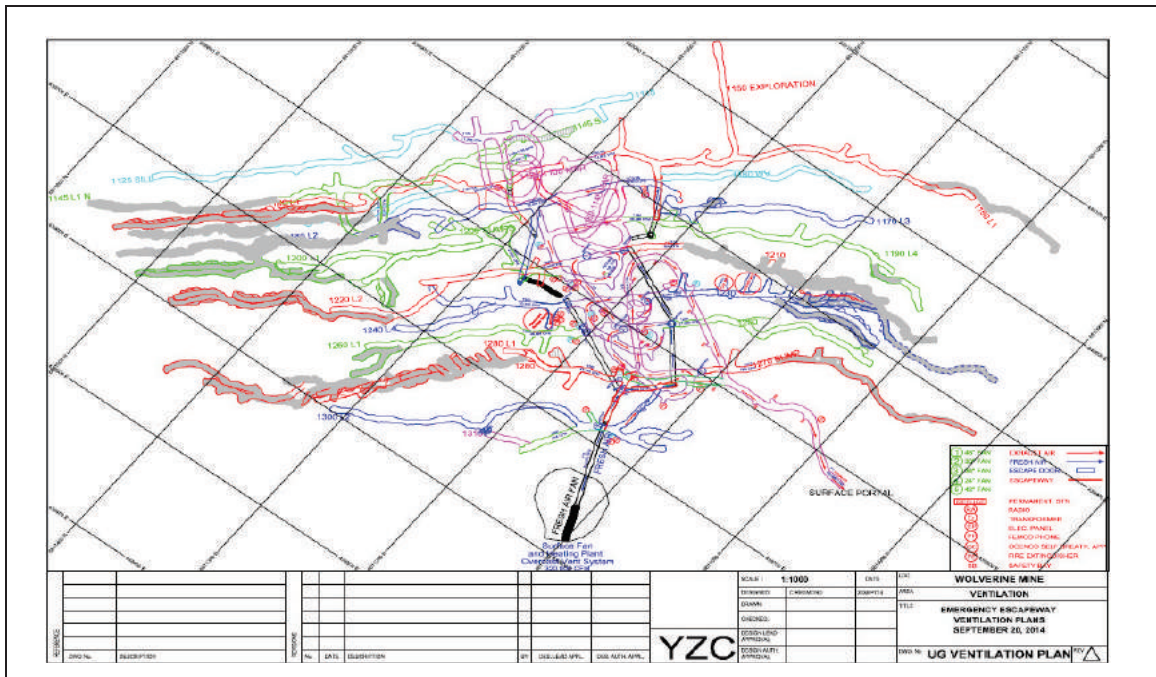

**Plan view mine drawings** provide an overhead view of a mine. Mines will have separate plans drawn for each level in the mine. They are drawn at various scales and the scale will always be noted on the drawing. A legend will be included to indicate the symbols used for fans, ventilation doors, shafts, raises, ore passes and so on. The symbols may vary from mine to mine.

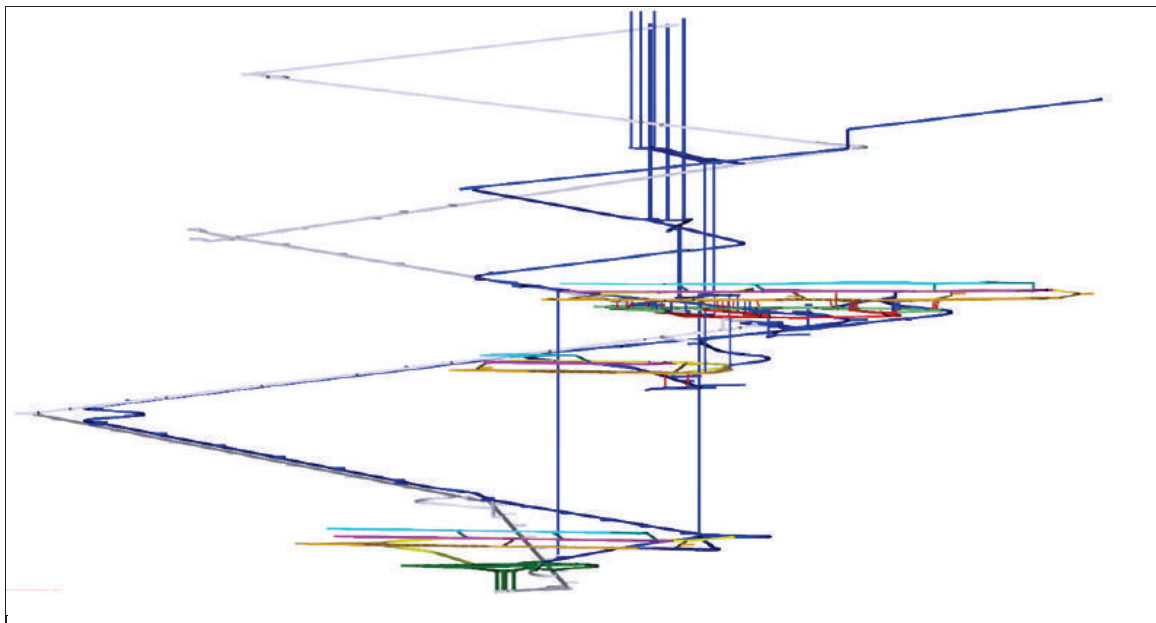

Mines with large vertical dimensions require the use of **sectional views** to obtain a good representation of the mine layout. A section can be thought of as a vertical plan. Mines may have one very long dimension and one short dimension, resulting in the use of two kinds of sections: longitudinal sections along the long dimension and cross-sections across the shorter dimension (the width of the ore body).

---

## UNDERGROUND MINE FIRES — CONTROL AND SUPPRESSION

Underground rescue workers must have a basic knowledge of the chemistry and behaviour of fire. Underground fires are classified in the same way as fires on surface and progress through the same four phases. Firefighting techniques are similar but have been adapted to take into account the unique conditions present underground.

### Methods

**Direct Attacks** are employed in the early stages of a fire by using agents such as water (hose lines), foam, fire extinguishers, rock dust or sand. Unless a fire can be put out within a few hours by direct attack, teams use an indirect method. **Note:** Rescuers must be aware of the hazards of water on super-heated rock (loose or spalling), electricity, steam conversion, and catastrophic failure of tires.

**Indirect Attacks** are used when a fire poses too many hazards to rescue teams to combat directly and only after all personnel in the mine have been accounted for. Methods include:

- Sealing
- Flooding with water
- Smothering with high-expansion foam, silt, fill, other solids or inert gas

**The decision to use an indirect attack can only be made by on-site incident command.**

### Sealing

Mine fires should be sealed when progress cannot be made by fighting them directly or when other conditions, such as inaccessibility or probable dangerous accumulations of explosive gas, make sealing advisable. Seals should be built on the intake and exhaust sides simultaneously. If this is not possible, the seal on the fresh air side should be put up first.

**If the exhaust side is sealed first, the rescue team will be in danger from the extremely toxic and hot atmosphere. The team will also face the danger of an explosion caused by explosive gases backing up over the seat of the fire.**

Stoppings should be set at an adequate distance in the opening and as close to the fire as safety permits. Allow enough room for a secondary seal. All ground in the vicinity of the stopping must be well checked and scaled down.

After sealing is complete, all non-mine rescue personnel must immediately leave the fire area until it is safe to return. If workers have been trapped in the mine, mine rescue teams must focus on rescuing them as soon as practical.

**Temporary seals** are erected in an effort to quickly exclude most of the air from a fire and are later supplemented by airtight permanent seals. Common types of temporary stoppings or seals include:

- Brattice, engineered fabric, or heavy-gauge plastic
- Sandbags
- Lumber



- Commercially available inflatable bulkheads

**Permanent seals** are constructed after erecting temporary seals, and should be built of heavy construction material strong enough to withstand an explosion, pressure, or crushing, such as:

- Brick
- Concrete
- Steel
- Shotcrete



### **Flooding with water**

Flooding an enclosed area of a mine with water is another way to deal with an out-of-control fire. Flooding is only performed as a last resort because it makes any later recovery work difficult in that area.

### **Deciding to Seal a Mine Fire**

There are no set rules for sealing mine fires. It is the duty of the rescue teams to collect as much information as possible about the fire and to relay this information to the emergency operations centre. In turn, it is the duty of emergency operations centre to evaluate the information and decide whether to seal the fire or continue to search for trapped or missing persons, but they must consider the welfare and the safety of the rescue teams at all times.

### **Deciding to Unseal a Mine Fire**

No attempts should be made to unseal a mine fire until:

- Oxygen content of the sealed atmosphere is low enough to eliminate the possibility of explosions
- Carbon monoxide (indicator of combustion) has been reduced to a safe level, and
- The temperature has cooled down well below the point of ignition

Gas tests of the atmosphere behind the stoppings should be taken at reasonable intervals as determined by the Emergency Operations Centre. Gas tests should be taken through the seal with as little disturbance as possible to the seal. Mine rescue teams testing gas levels must wear SCBAs.

### **Smothering**

High-expansion foam removes two legs of the fire triangle: oxygen and heat. The foam smothers and cools the fire at the same time. However, smothering foam can only be used to fight Class A and B fires. It is most commonly used in controlling fires that cannot be approached at a close range.

Teams should not travel through foam-filled areas because the foam can lead to difficulty hearing, blocked vision, and slick surfaces. Teams should clear the foam as much as possible, such as by using a water fog stream.



**Steam conversion in high-expansion foam may result in dangerously low oxygen levels.**

---

Silt, fill, or other solids can be used to smother a fire as well, but these materials can severely complicate recovery of the affected section of the mine. Inert gases, such as carbon dioxide or nitrogen, can also be used to smother a fire.

#### **Rescue Team Responses to Underground Mining Hazards**

- Dust or gas explosions
- Spontaneous combustion (underground coal mines)
- Ground failure
- Ground conditions (loose)
- Inundation by water or hazardous atmosphere
- Catastrophic mechanical or electrical failure

The primary roles of the rescue team responding to a suspected hazard are to ensure team safety, remove or protect workers, explore the aftermath, and assess conditions. Once this is completed, the teams will begin the process of rehabilitating the mine. The rehabilitation process includes re-establishing:

- Mine openings and safe travelways
- Ventilation systems
- Mechanical and electrical services
- Communications







---

## Western Canada Mine Rescue Manual

# Chapter 13 Operations Skills



---

## OBJECTIVES

This chapter provides **basic guidelines** for specific rescue operations skills. Upon completion of this chapter, the trainee shall be able to demonstrate knowledge of and/or competency in:

- Use of Portable Fire Extinguisher
- Structural Search and Rescue
- Casualty Management
- Rescue from Vehicles and Mobile Equipment
  - Stabilizing vehicles
  - Access
- Supplementary Mine Rescue Response Training

## USE OF PORTABLE FIRE EXTINGUISHERS

Knowing how to use a fire extinguisher is a key component of emergency response. It would be impossible to simulate every fire that may be encountered, as many other risks and hazards may be present. The following basic steps will work for most fires:

1. Determine the class, size, and phase of the fire. Select the extinguisher accordingly.
2. Quickly check the extinguisher before attempting to use it. Look for significant external damage.
3. Prepare the extinguisher, pull out the pin, or pressurize the cartridge type before approaching the fire.
4. Perform a quick test by activating trigger to determine functionality and wind direction if applicable.
5. Approach the fire from the upwind side (wind at your back), monitor wind change, and adapt if necessary.
6. Advance slowly and maintain a safe distance from the fire at all times.
7. Aim the nozzle at the base of the fire.
8. Squeeze the nozzle trigger to discharge.
9. Use a rapid sweeping motion to ensure the extinguishing agent reaches the base of the fire.
10. Overlap the flame edge of the fire.
11. Ensure the fire is extinguished.
12. Do not turn your back on a fire. Slowly back away and be prepared for re-ignition.
13. Set a fire watch.

**Certain fires and conditions may require specific techniques, such as extinguishing ignited pressurized gas vapour.**

## SEARCH AND RESCUE

**Structural search and rescue** involves entering a building experiencing hazardous conditions to ensure the safety of those inside. The purpose of structural search and rescue is to:

- Locate and remove trapped occupants
- Locate hazards (e.g., seat of the fire, fire extension, sources of toxic atmosphere)
- Identify and apply controls (ventilation, close doors/windows, fire suppression)

## Structural entry

- Identify and establish access and egress points
- Identify hazards (check doors, windows for heat, smoke, signage, contents)
- Gaining access through doors, windows, walls, forcible entry

## Basic door entry

Rescuers will encounter closed doors during their searches. Before entering any structure or room, rescuers must:

- Check door, knobs/handles and hinges for heat and thermal line
- Observe and assess for any smoke/fire
- Determine entry by the direction in which the door swings. Keep low, open the door slowly, and be aware of the potential for backdraft.

## Interior search and rescue

- **Primary searches** are conducted in the most critical areas first.
- **Secondary searches** are conducted after initial fire suppression/ventilation.
- Both searches follow a systematic search pattern. For example, the left- or right-handed search.

## STANDARD SEARCH PROCEDURE

Mine rescue teams must follow certain protocols and procedures so that they can respond to emergencies as efficiently and safely as possible. **Search teams** are a fundamental part of these procedures. Teams consist of:

- A minimum of two personnel
- A rapid intervention team (RIT or back-up) on standby, established before entry
- Equipment (hand light, gas detection equipment, breathing apparatus, entry tool, thermal imaging camera if available)

Fig 13-1: Standard search procedure for one- and two-search team arrangements

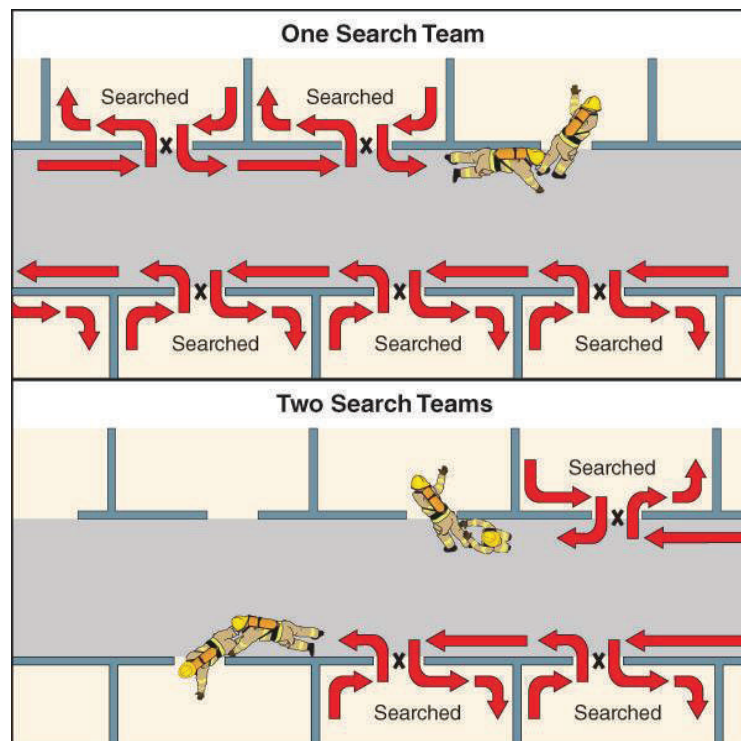

The **Primary Search** is a rapid, systematic search of the following:

- Most severely threatened areas
- Area with largest number of casualties
- Remainder of hazard zone
- Extension exposures

**Secondary searches** are thorough, systematic searches that ensure the entire structure is free of casualties and hazards. When possible, different personnel from those who performed the primary search should be used so that new sets of eyes can assess the scene.

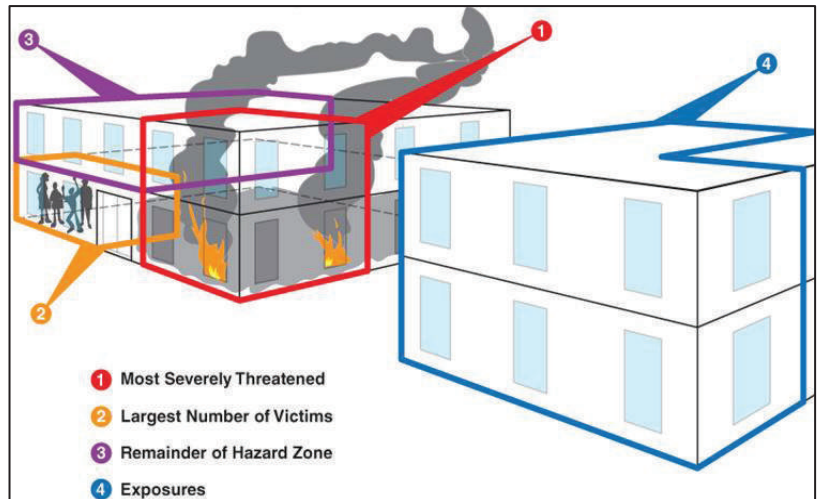
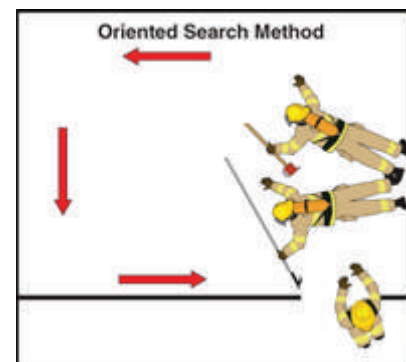
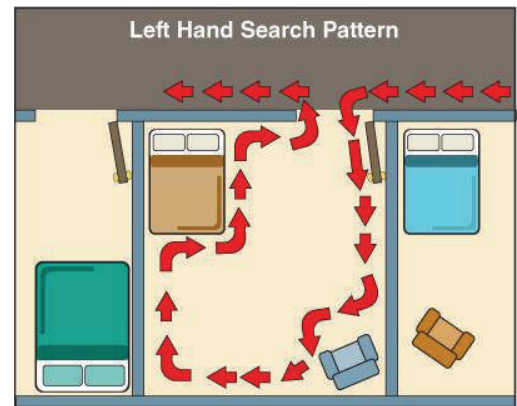

Fig 13-2: Areas to cover in the primary search, in priority order

**Search patterns** ensure that rescuers do not get lost or disoriented during a search. The team captain will determine which direction to use (left or right hand) prior to entering a structure. Search patterns will follow the walls until they return to the starting point. If rescuers keep turning in the original direction as they go in and out of rooms and arrive at the entry point, they have completed a search.

- If rescuers encounter a casualty or a problem during the search, they must reverse the direction they used upon entry to exit the structure.
- While performing the search, rescuers must maintain visual, tactile, or verbal communication to keep track of each other.
- Team members can extend their reach by using tools.
- How rescuers move will depend on the conditions found in the search area. For example, in smoke conditions, rescuers would crawl and move cautiously.



#### Areas to be searched

- Bathrooms, closets, and the spaces behind and under furniture should be checked.
- Check areas near windows for casualties overcome while attempting to reach a window.

#### Indicating that a room has been searched

- Close the door
- Indicate the room has been searched. Some examples are:
  - Mark an "x" on the door
  - If unable to close the door, place a chair behind the door so that the legs are pointing outwards
  - Communicate to command that a room has been searched

---

## CASUALTY MANAGEMENT

Locating, retrieving, and tending to casualties is the second fundamental principal of mine rescue operations. There are three types of casualties:

- Casualties already outside the hazard area
  - These casualties must be accounted for, given medical treatment as required, and removed to a safe zone
- Casualties attempting to leave the hazard area
  - These casualties must be secured, warned of hazards, and directed to safety
- Casualties trapped, unconscious, or otherwise unable to leave the hazard area
  - Rescuers will prioritize according to primary search principles

Injured casualties should not be moved before treatment is provided unless there is an immediate danger to the casualty or rescue team. Triage, a system of priority-based casualty management, is an essential component of multiple-casualty incidents.

## EXTRICATION FROM VEHICLES AND EQUIPMENT

This section provides an overview for rescuing casualties trapped in vehicles. The skills below can also be applied to extrication from stationary equipment. Prior to any work being done, hazards must be identified and controlled.

**Rescuers should never place themselves in a pinch point or danger zone while stabilizing. They must also be aware of vehicle airbags that have not deployed during a motor vehicle incident.**

After size up but before any other extrication activities, rescuers must stabilize the vehicle(s) and isolate potential energy sources, such as a raised box or boom. **Stabilization** is the process of providing additional support between an entrapping object (e.g., a vehicle) and the ground or other solid anchor points to prevent unwanted movement. This ensures the safety of the rescuers and prevents further injury to the casualties.

Vehicles should be stabilized to prevent both vertical and horizontal movement. Stabilization can be achieved using lifting bags, wood, tie down straps, ropes, jacks, cribbing, wheel chocks, or other specialized equipment.

### Gaining Access

Access to a casualty can be gained through:

- A normal operating door
- A window
- Removing parts or sections of the vehicle body

### Shut Down Electrical Systems

Rescuers must shut down all electrical systems within the vehicle to prevent complications such as movement and combustion. The main components are:

- Lock out/Isolation points
- Disconnecting batteries
- Removing keys from ignition

---

## Casualty Protection and Removal

It is critical to protect, monitor, and communicate with the casualty throughout the extrication. The guiding principle for extrication is to remove the vehicle from around the casualty.

Extrication can be accomplished with basic hand tools or power tools. Rescuers should be trained in the proper operation of the available tools.

**Casualties must be properly packaged before extrication unless their lives are in immediate danger.**

## SUPPLEMENTARY RESCUE TECHNIQUES

Supplemental training is needed to respond to various rescue situations, as identified by site-specific hazard identification procedures. These skills are beyond the scope of this manual. Some of these skills are listed below:

- Communications/command structure
- Fast water and ice rescue
- Avalanche response
- Confined spaces/hazardous atmospheres
- Hazardous materials/nuclear response
- Blasting procedures
- Technical rope rescue
- Fall protection
- Collapsed buildings and cave-ins
- Forcible Entry
- Vehicle extrication
- Heavy equipment operation
- Underground emergency operations
- Environmental (wildland fires) and wildlife
- Aircraft rescue and firefighting
- Site-specific fire response
- Structural firefighting
- Wilderness search and rescue

---

Western Canada Mine Rescue Manual

# **Appendix**

Provincial Certifications



BRITISH  
COLUMBIA

No. O ###

Ministry of Energy and Mines  
MINING AND MINERALS DIVISION

This

# Surface Mine Rescue Certificate

is awarded to

FIRSTNAME INITIAL LASTNAME of CITY, PROVINCE

for Basic Mine Rescue Work, having taken a course of training and passed an examination conducted by the Ministry of Energy and Mines.



Dated this XX<sup>th</sup> day of Month, 200X

Expires the XX<sup>th</sup> day of Month, 200X

Examining Inspector





BRITISH  
COLUMBIA

No. UG 00000

Ministry of Energy and Mines  
MINING AND MINERALS DIVISION

This

# Underground Mine Rescue Certificate

is awarded to

.....NAME..... of .....TOWN OR CITY, BRITISH COLUMBIA....

*for Basic Mine Rescue Work, having taken a course of training and passed an examination conducted by the Ministry of Energy and Mines.*



Dated this ...30<sup>th</sup>.....day of ...June, 2004.....

Expires the ...30<sup>th</sup>.....day of .....June, 2009.....

.....  
Examining Inspector







Certificate Number: \_\_\_\_\_

# Nunavut UNDERGROUND MINE RESCUE CERTIFICATE



This certifies

\_\_\_\_\_ received Mine Rescue training, and  
qualifies to use MINE RESCUE APPARATUS.

Dated at Yellowknife  
this \_ day of \_\_\_\_\_, 20\_\_

\_\_\_\_\_  
Chief Inspector of Mines

\_\_\_\_\_  
Examining Inspector of Mines

**WSCC** Workers' Safety & Compensation Commission  
ᐃᑦᑲᑦᐱᐃᓴᑦᑎᐱᐱᐱ ᐱᓴᓴ ᐱᓴᓴᐱᓴᓴᓴᓴᓴᓴᓴ

*Promoting workplace safety and care for injured workers.*





No. YT-SUR-0001

*Yukon Workers' Compensation Health and Safety Board  
Occupational Health and Safety*

**This**  
**Surface Mine Rescue Certificate**

is awarded to

ANY PERSON

of

WHITEHORSE, YT

for Basic Mine Rescue Work, having taken a course of training and passed an examination conducted by the Yukon Workers' Compensation Health and Safety Board.



Dated this 25<sup>th</sup> day of March 2015

Expires this 25<sup>th</sup> day of March 2015

Examining Safety Officer



No. YT-UG-0001

Yukon Workers' Compensation Health and Safety Board  
Occupational Health and Safety

This  
**Underground Mine Rescue Certificate**

is awarded to

ANY PERSON

of

WHITEHORSE, YT

for Basic Mine Rescue Work, having taken a course of training and passed an examination conducted by the Yukon Workers' Compensation Health and Safety Board.



Dated this 25th day of March 2015

Expires this 25th day of March 2015

Examining Safety Officer